

AXAX Tools

*The Leading Manufacturer of Forged Hand
and Power Tool Accessories Since 1946*

Hand Tools
Rigger Tools
Drill Steel Tools
Oilers & Lubricators
Electric Hammer Tools
Chipping Hammer Tools
Mounted Breaker Tools
Paving Breaker Tools
Wedges & Scrapers
Rivet Buster Tools
Weld Flux Tools
Zip Gun Chisels
Safety Tools



VALUE thru PERFORMANCE

- Since 1946 Ajax has continuously built on its expertise and its manufacturing processes, earning a reputation of uncompromising dedication to quality and service
- Made in U.S.A. and Owned and Operated by the Benedict family for over three generations, serving major market segments in automotive, industrial and construction, recognized as the "Vendor of Choice"
- Ajax Products Meet or Exceed O.E.M. Specifications
- In Stock, over 2500 styles of hand and power tool accessories for all pneumatic, electric and hydraulic percussion hammers
- Ajax has designed and manufactured thousands of custom tools meeting your specific application challenges

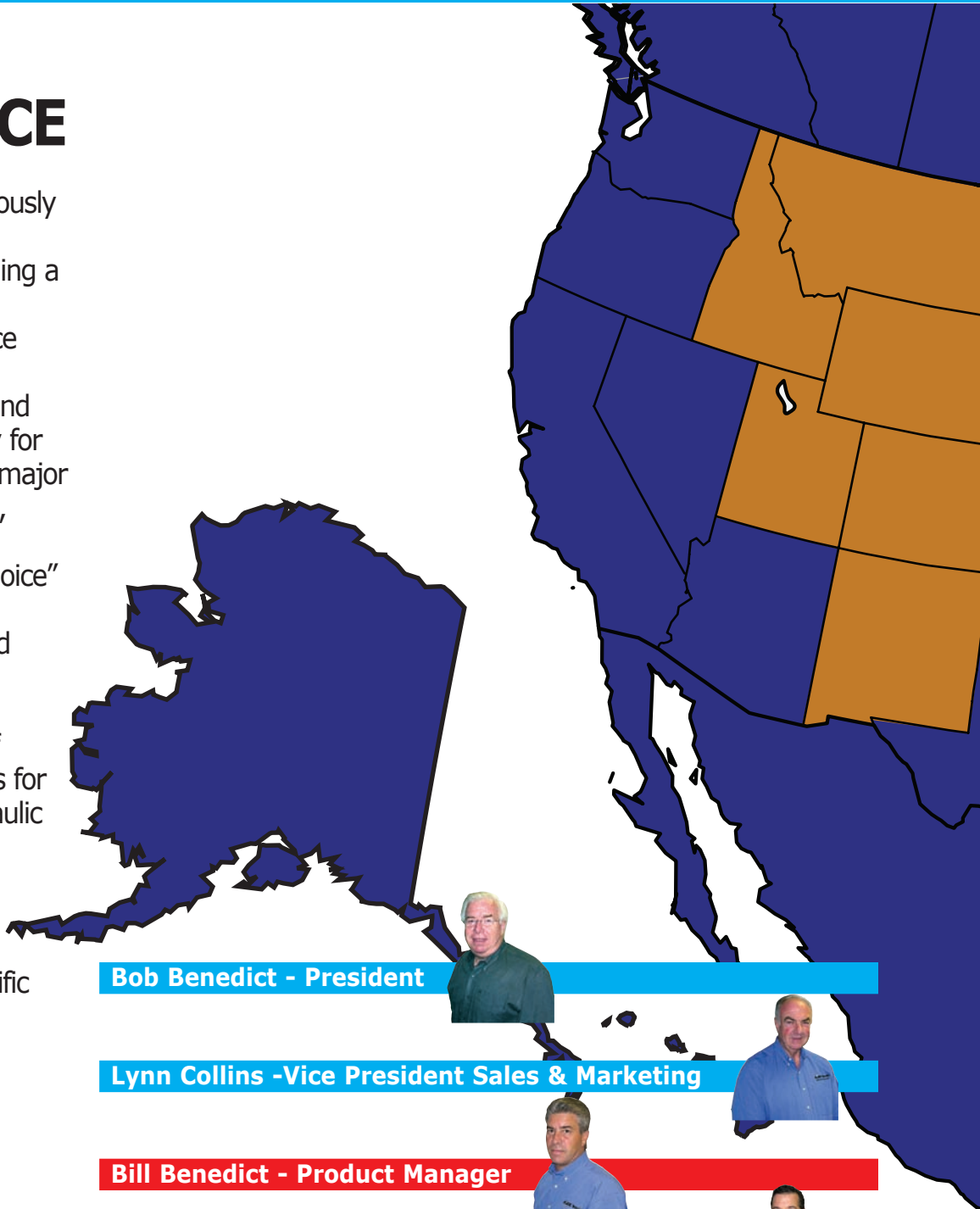

Bob Benedict - President



Lynn Collins - Vice President Sales & Marketing



Bill Benedict - Product Manager



Bob MacPherson - Northeast Regional Manager



Larry Smith - Southeast Regional Manager



Jim Federici - Midwest Regional Manager



Steve Tisdall - Westcoast Regional Manager





Table of Contents

ZIP GUN CHISELS & ACCESSORIES

Turn Type Chisels	6,7,9
Non-Turn Type Chisels	8
Chisel Sets	9
Rivet Sets	9
Retainers	10
Needle Scaler Attachment	10
Accessory Items	11

WELD FLUX CHISELS & ACCESSORIES

Chisels	12,13
Chisels for Long Reach Scalers	13
Needle Scaler Attachments & Parts	14

CHIPPING HAMMER TOOLS & ACCESSORIES

Non-Collar Chisels	15
Oval Collar Chisels	16
Round Collar Chisels	17
Hose Swivels	19
Retainers	18

BERYLLIUM COPPER SAFETY TOOLS

Safety Tools	20
--------------	----

RIVET BUSTER TOOLS & ACCESSORIES

Chisels	21
Retainers	22
Sleeves	22
Bumpers	22
Springs	22

PAVING BREAKER TOOLS

7/8" thru 1-1/4" Shanks	24,25
-------------------------	-------

DRILL STEEL TOOLS

Carbide Speed Bits	26
Carbide Utility Bits	26
Roto Hammer Chisels & Adapters	26
Drill Rods	27
Carbide & Steel Rock Bits	27

ELECTRIC HAMMER TOOLS

SDS Max Shank	28
5/8" Round Spline Shank	28
3/4" Hex Demo Shank	28
SDS Plus Shank	29
7/8" Hex Hilti Shank	29
1 1/8" Hex Shank	29

RIGGER TOOLS

Drift Pins	30
Pull Pins	30
Welding Pins	30
Broad Head Bull Pin	30
Pry Bars	31
Lining Bars	31
Connecting Bars	31
Fit Up Bars	31
Pinch Bars	31
Digging Bars	31
Cotter Pin Tools	31

HAND TOOLS

Chisels	32
Punches	32

WEDGES, LINE UP PINS & SCRAPERS

Stock Wedges	33
Flange Wedges	33
Flange Line-Up Pins	33
Flange Scraper	33

DEMOLITION TOOLS

Hydraulic Mounted Breaker Tools	34
---------------------------------	----

Terms and Conditions

TERMS AND CONDITIONS OF SALE

We at Ajax attempt to use the finest alloy steels available for our type of products. All machining, forging and heat treating is of the highest possible standards. We want you, our customer, to realize full value in every Ajax product you purchase.

All previous quotations, catalogs and price lists are hereby withdrawn and considered void. They are replaced by this catalog and our most current price list.

Prices are subject to change without notice. Orders are accepted at the price in effect at the time an order is received. Cancellation of orders are accepted only on our terms.

TERMS AND SHIPPING:

Our terms are net 30 days from date of invoice. All shipments are made FOB Franklin Park, Illinois.

All requests to return goods must be submitted in writing to our Customer Service Manager. Your request must reference the following: A) Ajax Part Numbers and Quantities you are returning. B) Your original Purchase Order Number or the Ajax Invoice Number.

If Ajax accepts the return the Customer Service Manager will issue an RMA (Return Material Authorization) number to accompany your return. No returns will be allowed without this RMA number. Upon his written authorization, all items must be returned Prepaid to our plant in Franklin Park, Illinois.

Credit will be issued only for standard items listed in the current Ajax Price Sheet. A 15% restocking fee will be charged against the Net value of the return. Additional charges will

apply should re-conditioning of products be necessary to return to our stock.

The amount credited will be determined by customer's original invoice for the items being returned.

An order for 2 times the value of returned goods must accompany the request to return. *No credit will be issued for: * Parts * Products over two years old * Used tools*

NON-CATALOG ITEMS:

Will be subject to quotation on price and minimum order quantity on an individual basis.

SHORTAGE OR DAMAGE:

Claims for shortage or deduction for erroneous charges must be presented promptly or they will not be honored. Risk of loss shifts to our customer upon tendering the goods to the transportation company at Franklin Park, Illinois. Never accept a shipment which arrives short or in bad condition until the agent makes proper notation on a paid freight bill.

OUR WARRANTY TO YOU:

AJAX WARRANTS ALL TOOLS TO BE FREE OF DEFECTS IN MATERIAL AND WORKMANSHIP.

REMEDY:

AJAX WILL REPLACE ALL TOOLS WHICH ARE DEFECTIVE IN MATERIAL OR WORKMANSHIP. THIS IS OUR EXCLUSIVE REMEDY TO OUR CUSTOMERS.

CAUTION:

Chisels and other striking tools are perhaps the most widely used and probably the most often abused of all tools. They are made in various types and sizes with varying degrees of

hardness and different configurations for specific purposes.

Ajax tools are used throughout the world by industry, foundries, railroads, contractors, automotive body men and hundreds of others. Each tool is designed for a particular job and should be used for that purpose only.

Air hammer chisels and points should never be used for prying, but for their intended use only.

Tools made for air hammers should never be used unless they are in the hammer. Never strike an air hammer tool with a hand hammer. Do not strike one hammer or sledge with another. Never strike another tool with the side or cheek of a hammer. Chiseling, punching and riveting should be done only with the proper type tool.

Keep tools in proper working condition. Discard any striking or struck tools if the face and its edges show excessive wear, dents, chips, mushrooming or improper redressing. Mushroomed heads may chip and cause injury. Never use a hammer with a loose or damaged handle.

Never redress chisels without the proper redressing instructions.

We cannot be responsible for injury or damage caused by tools improperly used or from tools which have been abused or badly worn. Eye protection, through the use of safety goggles or hood **MUST** be worn for any job involving the use of tools, particularly when using air hammers.

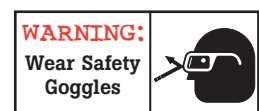

AJAX Tools

Shank Styles

Zip Gun Chisels (p. 6-9)

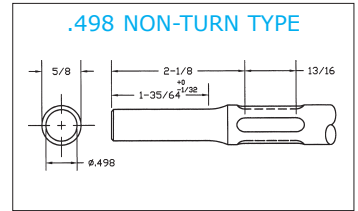
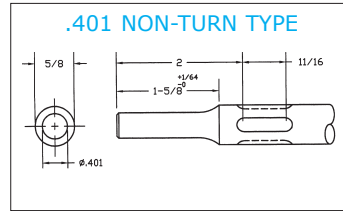
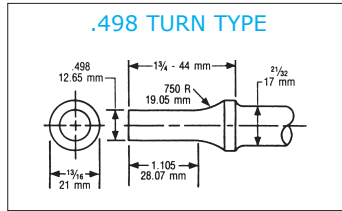
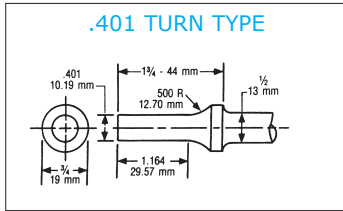

Weld Flux Hammer Chisels (p. 12-13)

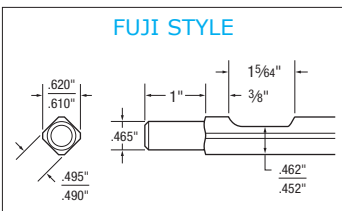
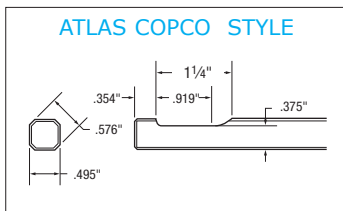
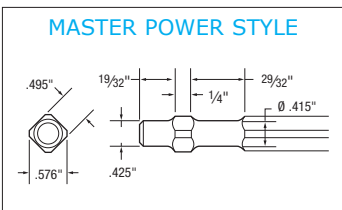
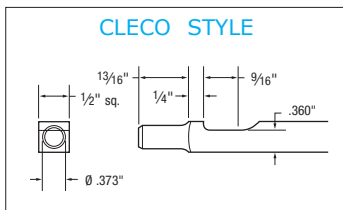
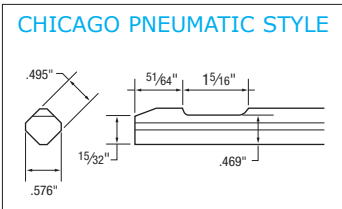
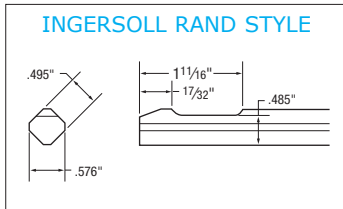

Chipping Hammer Chisels (p. 15-17)

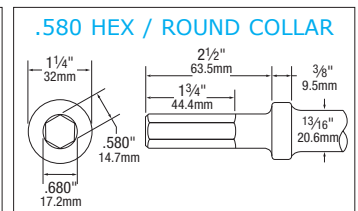
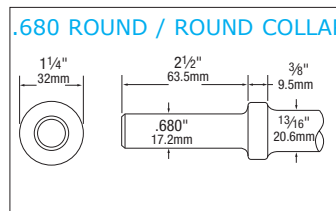
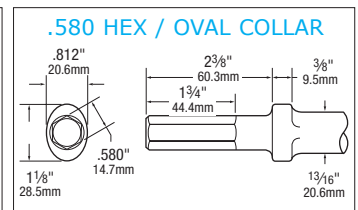
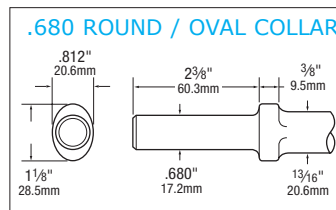
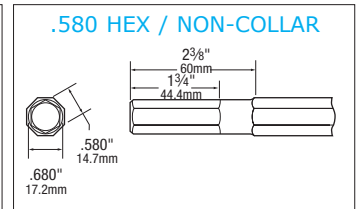
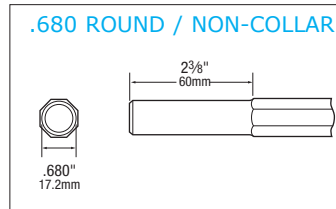

Rivet Buster Tools (p. 21)

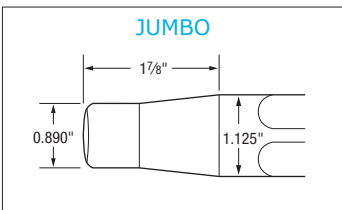
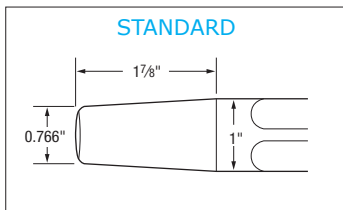

Electric Hammer Chisels (p. 28-29)

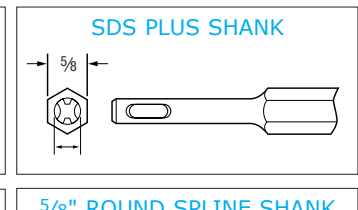
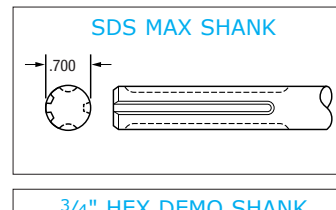

Paving Breakers (p. 24-25)

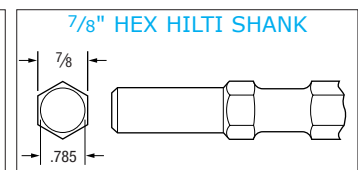
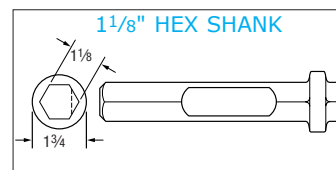
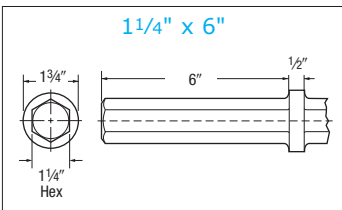
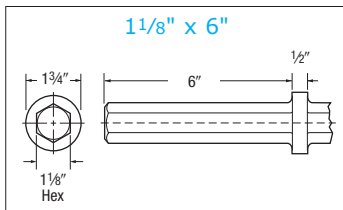
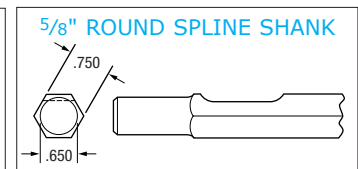
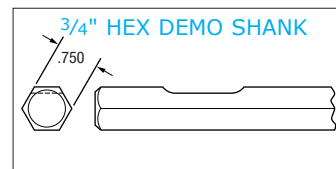
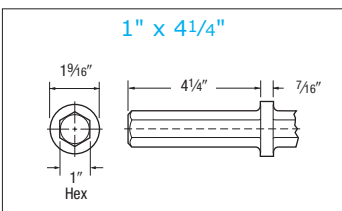
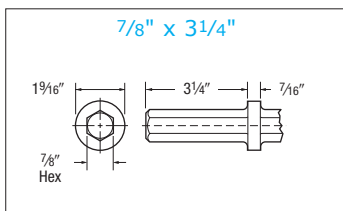

Zip Gun Chisels

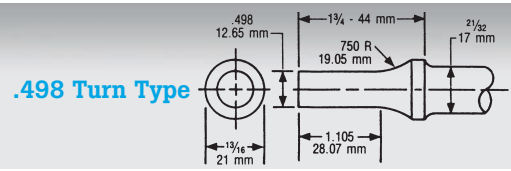
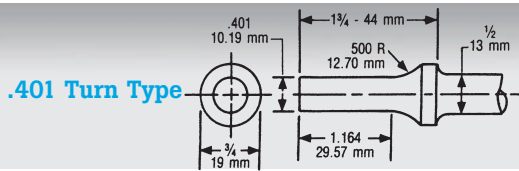

Universal Joint and Tie Rod Tool



No.	Shank Type	Length	Weight
901	.401	4 1/4"	.30 lbs.
965	.498	4 1/4"	.40 lbs.

Tail Pipe Cutter

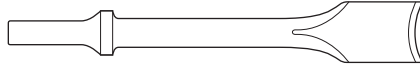

No.	Shank Type	Length	Weight
902	.401	6 7/8"	.30 lbs.

Fork Chisel

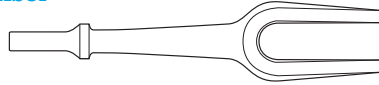

No.	Shank Type	Size	Length	Weight
903-5/8	.401	5/8"	7 1/4"	.70 lbs.
903-3/4	.401	3/4"	7 1/4"	.70 lbs.
903-1	.401	1"	7 1/4"	.70 lbs.
968	.498	1 1/4"	7 1/4"	.95 lbs.
968-1	.498	1"	7 1/4"	.75 lbs.

Bushing Remover Chisel



No.	Shank Type	Length	Weight
904	.401	6 1/4"	.30 lbs.

Wide Chisel & Scraper

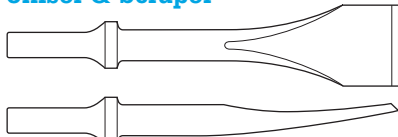

No.	Shank Type	Blade	Length	Weight
905	.401	1 5/16"	6 1/4"	.30 lbs.
955	.498	1 5/16"	7"	.50 lbs.

Bushing Splitter

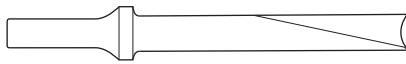

No.	Shank Type	Length	Weight
906	.401	6 1/4"	.30 lbs.
964	.498	7"	.50 lbs.

Claw Ripper/Edging Tool

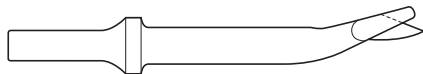

No.	Shank Type	Length	Weight
907	.401	5 3/8"	.30 lbs.

Muffler Cutter

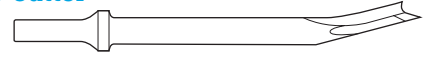

No.	Shank Type	Length	Weight
908	.401	7 1/2"	.40 lbs.

Double Blade Panel Cutter

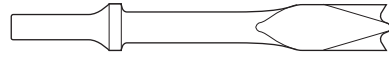

No.	Shank Type	Length	Weight
909	.401	6"	.30 lbs.
959	.498	6 7/8"	.50 lbs.

Flat Chisel

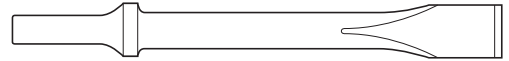

No.	Shank Type	Blade	Length	Weight
910	.401	3/4"	6 1/2"	.35 lbs.
910-1/2	.401	1/2"	6 1/2"	.30 lbs.
910-5/8	.401	5/8"	6"	.30 lbs.
910-11	.401	3/4"	11"	.60 lbs.
910-18	.401	3/4"	18"	1.00 lbs.
960	.498	5/8"	7"	.50 lbs.
960-12	.498	5/8"	12"	1.00 lbs.
960-18	.498	5/8"	18"	1.60 lbs.

Tapered Punch



No.	Shank Type	Length	Weight
911	.401	6 1/2"	.30 lbs.
961	.498	7"	.45 lbs.

Rivet Cutter

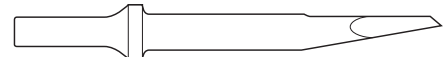
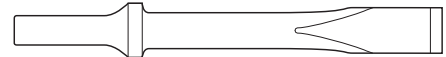

No.	Shank Type	Blade	Length	Weight
912	.401	5/8"	5 3/4"	.30 lbs.
962	.498	5/8"	5 3/4"	.40 lbs.

Wide Flat Chisel



No.	Shank Type	Blade	Length	Weight
910	.401	1 1/2"	6 1/2"	.40 lbs.
910-11-1-1/2	.401	1 1/2"	11"	.60 lbs.
910-2	.401	2"	7"	.50 lbs.
960-1-1/2	.498	1 1/2"	9"	.80 lbs.



WARNING:
Wear Safety
Goggles



Zip Gun Chisels

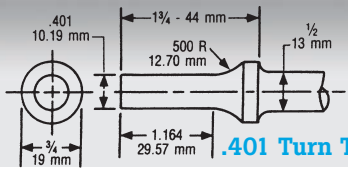

.401 Turn Type

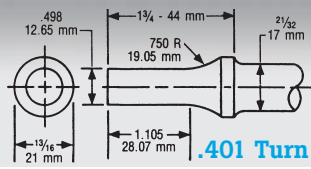

.401 Turn Type

Straight Punch

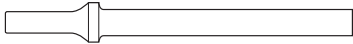

No.	Shank Type	Length	Weight
913	.401	6 1/2"	.30 lbs.
913-18	.401	18"	1.00 lbs.
963	.498	7"	.55 lbs.
963-18	.498	18"	1.60 lbs.

Vee Chisel/Spot Weld Breaker

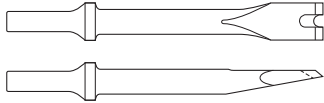

No.	Shank Type	Length	Weight
914	.401	6 1/4"	.30 lbs.

Piercing Punch



No.	Shank Type	Size	Length	Weight
916	.401	#6	5 1/2"	.30 lbs.
918	.401	#8	5 1/2"	.30 lbs.
920	.401	#10	5 1/2"	.30 lbs.

Flat Chisel Offset 30°

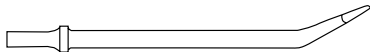

No.	Shank Type	Blade	Length	Weight
919	.401	5/8"	10 1/2"	.55 lbs.

Angle Chisel

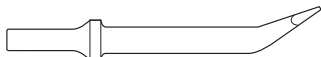
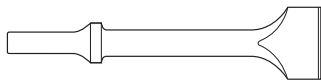

No.	Shank Type	Length	Weight
922	.401	6 3/4"	.35 lbs.

Single Blade Cutter

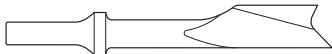

No.	Shank Type	Length	Weight
923	.401	5 3/4"	.30 lbs.

Pencil Point

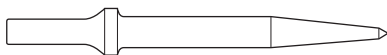

No.	Shank Type	Length	Weight
925	.401	6 1/2"	.30 lbs.
925-18	.401	18"	1.00 lbs.

Muffler & Pipe Cutter

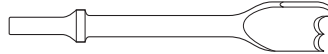

No.	Shank Type	Length	Weight
930	.401	7 1/2"	.30 lbs.

Kwik Cutter

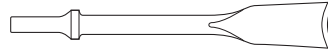

No.	Shank Type	Length	Weight
932	.401	8 1/2"	.40 lbs.

Muffler Cutters

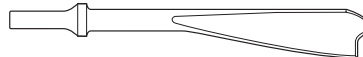

No.	Shank Type	Length	Weight
933 (Inside)	.401	8 1/4"	.40 lbs.
934 (Outside)	.401	8 1/4"	.40 lbs.

Moil Point

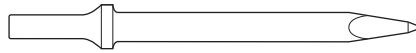

No.	Shank Type	Length	Weight
940	.401	7"	.35 lbs.

Hammer – 1" Diam.

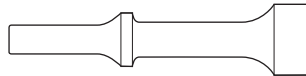

No.	Shank Type	Length	Weight
945	.401	4 1/4"	.30 lbs.
945-7	.401	7"	.45 lbs.
967	.498	4 1/4"	.40 lbs.

Undercoat Scraper

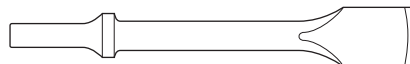

No.	Shank Type	Length	Weight
951	.401	6 1/2"	.35 lbs.

Nut Splitter

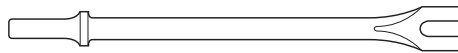

No.	Shank Type	Size	Length	Weight
1100	.401	5/16"	10"	.50 lbs.
1100-18	.401	5/16"	18"	1.00 lbs.
1101	.401	3/8"	10"	.50 lbs.
1101-18	.401	3/8"	18"	1.00 lbs.

Offset Bushing Splitter



No.	Shank Type	Length	Weight
921	.401	8 3/8"	.40 lbs.



AUTOMOTIVE

Auto body repair shops use them in general body repair or replacement.

Auto Service Centers use them on mufflers, shocks and front end repairs.

INDUSTRIAL

Motorcoach and R.V. builders use zip guns for sheet metal cutting, windows and doors.

Maintenance departments use them for general maintenance and repair. Foundries use them for chipping of small castings.

CONSTRUCTION

Maintenance departments doing machinery repair use zip gun tools.

WARNING:
Wear Safety Goggles



Zip Gun Chisels



Straight Punch

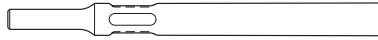

No.	Shank Type	Length	Weight
3101	.401	7"	.50 lbs.

Flat Chisel



No.	Shank Type	Blade	Length	Weight
3102	.401	3/4"	7 1/2"	.50 lbs.
3182	.498	3/4"	7 1/2"	.60 lbs.
3102-18	.401	3/4"	18"	1.40 lbs.
3182-18	.498	3/4"	18"	1.40 lbs.

Rivet Cutter

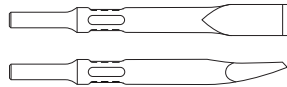

No.	Shank Type	Blade	Length	Weight
3103	.401	5/8"	7 1/2"	.50 lbs.
3183	.498	5/8"	7"	.50 lbs.

Single Blade Cutter



No.	Shank Type	Length	Weight
3104	.401	6 1/2"	.40 lbs.

Claw Ripper/Edging Tool



No.	Shank Type	Length	Weight
3105	.401	7"	.40 lbs

Wide Chisel & Scraper

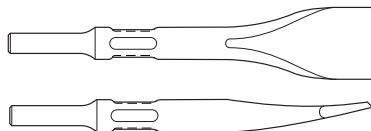

No.	Shank Type	Blade	Length	Weight
3106	.401	1 5/16"	7"	.55 lbs.
3185	.498	1 5/16"	7"	.55 lbs.

Piercing Punch



No.	Shank Type	Size	Length	Weight
3108-6	.401	#6	5 1/2"	.30 lbs.
3108-8	.401	#8	5 1/2"	.30 lbs.
3108-10	.401	#10	5 1/2"	.30 lbs.

Double Blade Panel Cutter

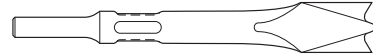

No.	Shank Type	Length	Weight
3109	.401	6 3/4"	.40 lbs.
3189	.498	9"	.70 lbs.

Tapered Punch



No.	Shank Type	Length	Weight
3110	.401	7"	.40 lb

Diamond Point



No.	Shank Type	Length	Weight
3111	.401	7 1/2"	.50 lbs.

Angle Chisel



No.	Shank Type	Length	Weight
3112	.401	7"	.50 lbs.

Tail Pipe Cutter

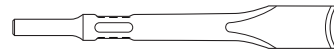

No.	Shank Type	Length	Weight
3114	.401	7 1/2"	.50 lbs.
3180	.498	9"	.60 lbs.



Ajax non-turn tools have four ball slots rather than a collar. This allows the retainer balls to seat into the slots, preventing the tool from turning. It also allows the tool to be indexed for different cutting positions. Must be used in an Ajax Kwik Change Retainer, No. 3300 and 3700 (see page 6).



.401 Shank Rivet Sets Overall Length: 31/2"

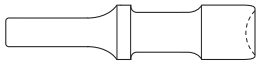

No.	Size	Head	Wt.	No.	Size	Head	Wt.
1604	3/16"	Round	.30	1620	3/16"	Brazier	.30
1605	1/4"	Round	.30	1621	1/4"	Brazier	.30
1606	5/16"	Round	.30	1622	5/16"	Brazier	.30
1610	3/16"	Mod. Braz.	.30	1636	3/16"	Universal	.30
1611	1/4"	Mod. Braz.	.30	1637	1/4"	Universal	.30
1612	5/16"	Mod. Braz.	.30	1638	5/16"	Universal	.30

.401 Shank Roll Pin Drivers



No.	Punch Diam.	Roll Pin No.	Length	Weight
1102	1/4"	8	7 1/2"	.20 lbs.
1103	5/16"	9	7 1/2"	.25 lbs.
1104	3/8"	10	7 1/2"	.30 lbs.
1105	1/2"	12	7 1/2"	.40 lbs.
1106	Set of 4 (A1102, A1103, A1104, A1105)			

.401 Shank Bushing Driver

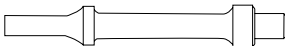

No.	Shank Type	Pilot	Length	Weight
1126	.401	1/2"	5 1/2"	.35 lbs.
1127	.401	1/2"	9 1/2"	.55 lbs.

Square Drive Socket Adaptors



No.	Shank Type	Pilot	Length	Weight
1129	.401	3/8"	5"	.50 lbs.
1130	.401	1/2"	5 1/2"	.60 lbs.

*Used to loosen tight fasteners, adapts to 3/8" & 1/2" Impact Sockets.

Hand Held Fork Tool

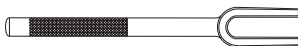

No.	Size	Length	Weight
528	3/4"	12"	1.50 lbs.
529	1"	12"	1.50 lbs.

.401 Shank Panel Crimper



No.	Length	Weight
944	7"	1.75 lbs.

.401 Shank Smoothing Hammers

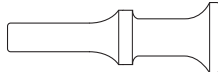

No.	Shank Type	Hammer Diam.	Length	Weight
1600	.498	1"	3"	.30 lbs.
1601	.498	1 3/4"	3 1/4"	.40 lbs.
1602	.401	1"	3"	.20 lbs.
1603	.401	1 3/4"	3 1/4"	.40 lbs.

.401 Shank Hinge Pin Drivers

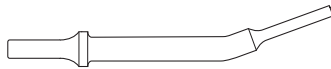

No.	Description	Length	Weight
1110	Set of 2 (A1111 & A1112)	7 3/8"	.70 lbs.
1111	Hinge Pin Driver, .237 dia.	7 3/8"	.30 lbs.
1112	Hinge Pin Driver, .302 dia.	7 3/8"	.30 lbs.

Adapter Extension for 1126 & 1127



No.	Pilot	Length	Weight
1128	1/2"	5"	.70 lbs.

.401 Shank Valve Guide Drivers

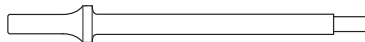

No.	Body	Pilot	Length	Weight
1121	.420"	1/4"	7 1/2"	.30 lbs.
1122	.420"	5/16"	7 1/2"	.30 lbs.
1123	.480"	11/32"	7 1/2"	.40 lbs.
1124	.480"	3/8"	7 1/2"	.40 lbs.
1125	.480"	7/16"	7 1/2"	.50 lbs.

.401 Shank Freeze Plug Installation Sets

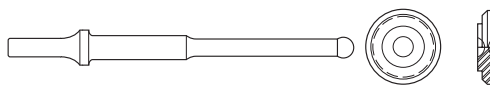

No.	Description	Weight
1160	Freeze Plug Installation Set (contains one each A1161, A1162-1, A1162-2 and A1162-3)	1.40 lbs.
1161	Driver, 14" OAL.	.70 lbs.
1161-22	Driver, 22" OAL. (Opt.)	1.10 lbs.
1162-1	Head fits 1" & 1 3/8" (25mm & 35mm)	.15 lbs.
1162-2	Head fits 1 25/64" & 1 5/8" (35.3mm & 41.2mm)	.20 lbs.
1162-3	Head fits 1 3/4" & 2 1/16" (44.4mm & 52.3mm)	.30 lbs.

WARNING:
Wear Safety Goggles



CHISEL SETS

9029

Nine-piece master set to handle the wide range of the professional's pneumatic chisel requirements.



Contains:

- 905 Wide Chisel & Scraper
- 906 Bushing Splitter
- 907 Claw Ripper/Edging Tool
- 908 Muffler Cutter
- 909 Double Blade Panel Cutter
- 910 Flat Chisel
- 911 Tapered Punch
- 912 Rivet Cutter
- 932 Kwik Cutter

9024

Primary set of pneumatic chisels to fill the most basic needs.



Contains:

- 906 Bushing Splitter
- 908 Muffler Cutter
- 910 Flat Chisel
- 912 Rivet Cutter

9044

Pneumatic chisels for the body specialist.



Contains:

- 902 Tail Pipe Cutter
- 907 Claw Ripper/Edging Tool
- 909 Double Blade Panel Cutter
- 914 Spot Weld Breaker

9034

Four-piece set of the essential exhaust system chisels.



Contains:

- 908 Muffler Cutter
- 932 Kwik Cutter
- 933 Inside Muffler Cutter
- 934 Outside Muffler Cutter

Zip Gun Chisels – Retainers / Attachments



3300, 3200, 3700 Retainers

These Ajax Kwik Change Retainers are threaded exactly to the manufacturer's specifications. The 3300 retainer is for use with .401 standard turn-type or non-turn type tools. 3200 retainer is for .498 standard turn-type tools and 3700 retainer is for .498 non-turn type tools. See chart to find the right retainer for your hammer or specify make and model of hammer when ordering. * See chart below.



3300-U Retainer

This Kwik Change Retainer may be used with .401 standard turn-type or non-turn type tools. It features a pliable insert that adapts to most models of hammer. * See chart below.

Retainer Replacement Parts

Description	3200	3300	3300-U	3700
Lock Screw	3304	3304	—	3304
Body*	3204	3301	3301-U	3701
Balls (4)	3013	3013	3013	3013
Spring	3206	3014	3014	3014
Sleeve	3205	3302	3302	3010
Front Snap	3207	3016	3016	3705
Washer				
Back Snap	3208	3306	—	3208
Washer				
Nylon Insert*	3210	3310	3310-U	3710

*Specify Make and Model of Hammer

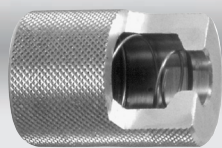

893 Chisel Holder Retainer Chuck

Replaces conventional spring retainer. Fits most .401 hammers. Weight .20 lbs.

Retaining Springs

895 .401 Std. Beehive Spring (CPA 046096)
 895-IR .401 Std. Beehive Spring (AVC-183)
 895-SX .401 Std. Beehive Spring (SX# 2207)
 898 .498 Beehive (CPA 047096)



896 .498 Mech Aid (CPA 047095)
 897 .401 Mech Aid (CPA 046095)
 897-IR .401 Mech Aid (AVC-183A)



899 .401 Beehive Spring & Washer (Sioux 2208)



900 .401 Mech Aid (B&D 58616)



3500 Needle Scaler Attachment



Replacement Parts

3501* Body with Insert
 3505 Front Snap Washer
 3502 Driver
 375 Needle Holder
 3503 Spring
 1376 Set of 19 Needles (5")
 3504 Front Bushing
 3304 Set Screws (3)

Threads onto .401 hammers to make an instant needle scaler. Ideal for paint, rust, weld flux removal and more.

*Specify Make and Model Hammer

Manufacturer	Model	3300	3300-U	3200	3500	3700
		.401 Turn or Non-Turn Type Tools	.401 Turn or Non-Turn Type Tools	.498 Turn Type Tools	.401 Type Needle Scaler	.498 Non-Turn Type Tools
American Pneumatic	All models	3300-1			3500-1	
Bosch	All models	3300-43				
Chicago Pneumatic	4447-717			3200-3		3700-3
Chicago Pneumatic	9311-9315, 711-715	3300-9	3300-U		3500-9	
Cleco	E3-E4-E15-E16	3300-9	3300-U		3500-9	
Craftsman	18800	3300-9	3300-U		3500-9	
Dayton	All models	3300-9	3300-U		3500-9	
Desouter	All models	3300-1			3500-1	
Florida Pneumatic	All models	3300-10	3300-U		3500-10	
Ingersoll-Rand	AVC-26			3200-1		3700-1
Ingersoll-Rand	115, 116, 117	3300-9	3300-U		3500-9	
Ingersoll-Rand	121, 132, 772	3300-1			3500-1	
Ingersoll-Rand	AV10-12-13	3300-1			3500-1	
Sioux	270-272	3300-1			3500-1	
Snap-On	PH45-PH50	3300-10	3300-U		3500-10	
Superior	All models	3300-1			3500-1	

NOTE: Retainers for other models available on request.



Zip Gun Chisels – Accessory Items

- 1012 1/2" Chuck for 1/2" Sq. Drive
 1014 3/8" Chuck for 3/8" Sq. Drive

Chuck slips onto square spindle and transforms your impact wrench into an efficient drilling tool.

Impact Wrench Chuck



- 1070 Attaches directly to any air tool.
 1/4" Male x 1/4" Female NPT. Adjustable flow rate.
 Holds 9 CCs of oil.

Oiler / Midget Oiler



- 1071 High-impact plastic reservoir allows operator to see when refill is necessary.

- 1094 1/4" NPT
 1095 3/8" NPT

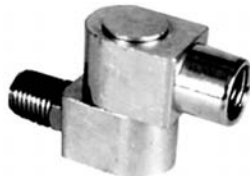

360° Hose Swivel

Pressure-Feed Pneumatic Tool Lubricators



1066



1067



1068



1069

Pressure-feed lubricators increase the life and productivity of your air tools and are easily installed on any air line, hose, compressor or air tool. When the tool is started a momentary pressure drop occurs and back pressure forces a fog of oil into the air stream to the tool. This operation repeats each time the tool is operated as long as the reservoir has oil. This may be checked through the pressure-proof window or window cap. The adjustable feeder allows you to set the lubricator valve for all climates and conditions. Refilling is easy: just remove the manual relieving safety filler cap and fill the reservoir.

MODEL	LENGTH	WIDTH	HEIGHT	WEIGHT	OIL CAP.	PIPE SIZE	CAP. FREE AIR	SAFETY FACTOR
1066	4 1/2"	2 3/8"	2 13/16"	16 OZ.	7 CU. IN. 2.6 OZ.	1/2" NPT	100 SCFM	500
1067	6"	2 7/8"	3 3/8"	26 OZ.	12 CU. IN. 5.3 OZ.	3/4" NPT	175 SCFM	260
1068	7"	3 3/8"	3 11/16"	34 OZ.	18 CU. IN. 8 OZ.	3/4" NPT	175 SCFM	300
1069	10"	3 7/8"	4 3/16"	70 OZ.	34 CU. IN. 16 OZ.	1" NPT	350 SCFM	250
1066SG SIGHT GLASS CAP								
1066-1 O-RING								

AIR REGULATORS



- 894**
(CPT No. CA 085203)
 For tools with 1/4" threaded inlet. Spring loaded lock type arrangement stays at your setting and restricts air flow to suit your needs.



- 889 Brass**
890 Aluminum
 Increase or decrease pressure as needed. 1/4" Male x 1/4" Female NPT.

WARNING:
 Wear Safety Goggles



Weld Flux Scaling Hammer Chisels



INGERSOLL RAND STYLE SHANK

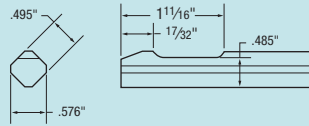



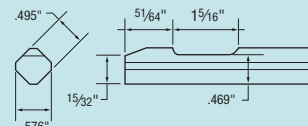



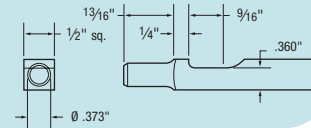

CHICAGO PNEUMATIC STYLE SHANK

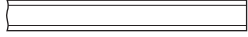
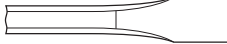
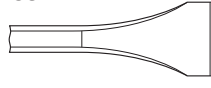

CLECO STYLE SHANK



POINT STYLE

	CAT. NO.	LENGTH	WIDTH	WT	CAT. NO.	LENGTH	WIDTH	WT	CAT. NO.	LENGTH	WIDTH	WT
Blank												
	381	7"	—	.4 lbs	395	7"	—	.4 lbs	391	7"	—	.4 lbs
	381-12	12"	—	.7 lbs	395-12	12"	—	.7 lbs	391-12	12"	—	.7 lbs
	381-18	18"	—	1.2 lbs	395-18	18"	—	1.2 lbs	391-18	18"	—	1.2 lbs
Flat Chisel												
	382	7"	3/4"	.4 lbs	396	7"	3/4"	.4 lbs	392	7"	3/4"	.4 lbs
	382-12	12"	3/4"	.7 lbs	396-12	12"	3/4"	.7 lbs	392-12	12"	3/4"	.7 lbs
	382-18	18"	3/4"	1.2 lbs	396-18	18"	3/4"	1.2 lbs	392-18	18"	3/4"	1.2 lbs
Scaling Chisel												
	383	7"	1 3/8"	.4 lbs	397	7"	1 3/8"	.4 lbs	393	7"	1 3/8"	.4 lbs
	383-12	12"	1 3/8"	.7 lbs	397-12	12"	1 3/8"	.7 lbs	393-12	12"	1 3/8"	.7 lbs
	383-18	18"	1 3/8"	1.2 lbs	397-18	18"	1 3/8"	1.2 lbs	393-18	18"	1 3/8"	1.2 lbs
Wide Scaling Chisel												
	380	7"	2"	.5 lbs	399	7"	2"	.5 lbs	390	7"	2"	.5 lbs
	380-12	12"	2"	.8 lbs	399-12	12"	2"	.8 lbs	390-12	12"	2"	.8 lbs
	380-3	7 1/2"	3"	.8 lbs	399-3	7 1/2"	3"	.8 lbs	390-3	7 1/2"	3"	.8 lbs
Angle Chisel												
	384	7"	1 3/8"	.4 lbs	398	7"	1 3/8"	.4 lbs	394	7"	1 3/8"	.4 lbs
	384-12	12"	1 3/8"	.7 lbs	398-12	12"	1 3/8"	.7 lbs	394-12	12"	1 3/8"	.7 lbs
	384-18	18"	1 3/8"	1.2 lbs	398-18	18"	1 3/8"	1.2 lbs	394-18	18"	1 3/8"	1.2 lbs
Cape Chisel												
	3229	7"	5/16"	.4 lbs	3226	7"	5/16"	.4 lbs	3232	7"	5/16"	.4 lbs
Round Nose Chisel												
	3228	7"	5/16"	.4 lbs	3225	7"	5/16"	.4 lbs	3231	7"	5/16"	.4 lbs
Diamond Point												
	3227	7"	1/4"	.4 lbs	3224	7"	1/4"	.4 lbs	3230	7"	1/4"	.4 lbs
Single Blade Panel Cutter												
	3221	7"	—	.4 lbs	3201	7"	—	.4 lbs	3241	7"	—	.4 lbs
Heavy Blade Flat (Rounded Point)												
					3280	7"	1 1/4"	.8 lbs				
					3280-12	12"	1 1/4"	1.1 lbs				
					3280-18	18"	1 1/4"	1.6 lbs				

Weld Flux Scaling Hammer Chisel Sets

9025

Ingersoll Rand Style Shank

Contains one each:

#381 Blank 7" OAL

#382 3/4" Wide
Chisel 7" OAL

#383 1-3/8" Wide
Chisel 7" OAL

#384 1-3/8" Angle Chisel 7" OAL



9026

Cleco Style Shank

Contains one each:

#391 Blank 7" OAL

#392 3/4" Wide
Chisel 7" OAL

#393 1-3/8" Wide
Chisel 7" OAL

#394 1-3/8" Angle
Chisel 7" OAL



9027

Chicago Pneumatic Style Shank

Contains one each:

#395 Blank 7" OAL

#396 3/4" Wide
Chisel 7" OAL

#397 1-3/8" Wide
Chisel 7" OAL

#398 1-3/8" Angle Chisel 7" OAL



Weld Flux Scaling Hammer Chisels

MASTER POWER STYLE SHANK

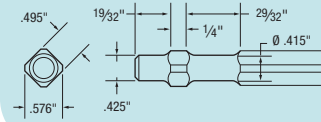

ATLAS COPCO STYLE SHANK

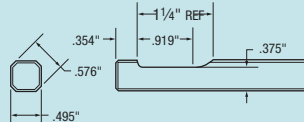

FUJI STYLE SHANK

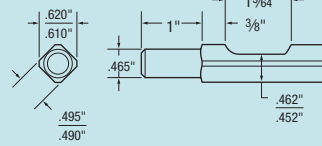

CAT. NO.	LENGTH	WIDTH	WT.	CAT. NO.	LENGTH	WIDTH	WT.	CAT. NO.	LENGTH	WIDTH	WT.
385	7"	—	.4 lbs	3250	7"	—	.4 lbs				
385-12	12"	—	.7 lbs	3250-12	12"	—	.7 lbs				
385-18	18"	—	1.2 lbs								
386	7"	3/4"	.4 lbs	3251	7"	3/4"	.4 lbs	3254	7"	3/4"	.4 lbs
386-12	12"	3/4"	.7 lbs	3251-12	12"	3/4"	.7 lbs				
386-18	18"	3/4"	1.2 lbs								
387	7"	1 3/8"	.4 lbs	3252	7"	1 3/8"	.4 lbs	3255	7"	1 3/8"	.4 lbs
387-12	12"	1 3/8"	.7 lbs	3252-12	12"	1 3/8"	.7 lbs				
387-18	18"	1 3/8"	1.2 lbs								
388	7"	1 3/8"	.4 lbs	3253	7"	1 3/8"	.4 lbs	3256	7"	1 3/8"	.4 lbs
388-12	12"	1 3/8"	.7 lbs	3253-12	12"	1 3/8"	.7 lbs				
388-18	18"	1 3/8"	1.2 lbs								
389	7"	2"	.5 lbs								

POINT STYLE

Blank

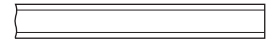

Flat Chisel

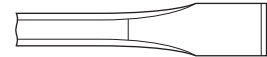

Scaling Chisel

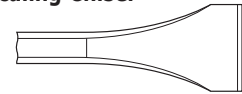

Angle Chisel

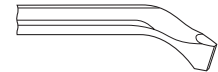

Wide Scaling Chisel



Pneumatic Scaling Hammer Chisels for long reach scalers

- 3284 4" Wide with Holes Length: 8 3/4"
- 3285 4" Wide Flex Blade
- 3286 8" Wide Flex Blade
- 3287 12" Wide Flex Blade

Flex Blades come with 2 ea.: Bolt, Washer, Nut

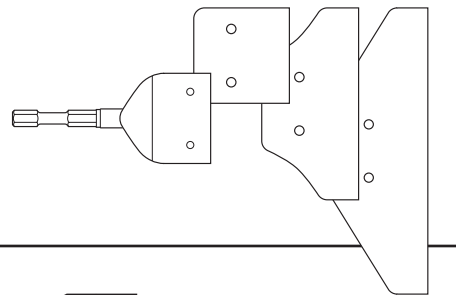

3281 Width: 1" Length: 8"



3282 Width: 2" Length: 8"

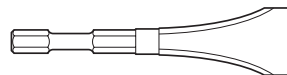

3283 Width: 4" Length: 8 3/4"

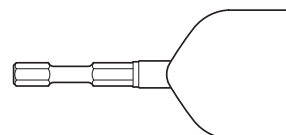

19/32" HEX SHANK

These chisels fit the following scalers:
 Edco
 ALR-2, ALR-4, ALR-5
 MacDonald
 LPS3, SPS5
 Master Power
 5195
 Trelawny
 136.3299, 136.3499,
 136.3599, 136.3699

WARNING:
 Wear Safety
 Goggles



Weld Flux Scaler Parts & Accessories

NEEDLE SCALER ATTACHMENT

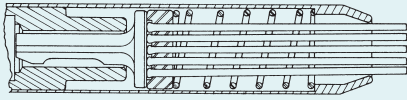

Conversion Units – make any weld flux hammer an instant needle scaler with units listed.

Cat. No.	Driver	Holder	Needle Set	Spring	Tube
1390	374	375	1376	1371	1380
For C.P.T. 456 & Jet					
1391	371	375	1376	1371	1380
For I-R Series 171 & 181					
1392	373	375	1376	1371	1370
For Cleco B1A, Aro 8500, C.P.T. 9356 & Ajax 1045					
1393	371	375	1376	1371	1360
For I-R Series 172 & 182					

AUTOMOTIVE

Auto body repair shops use needle scalers to remove rust.

INDUSTRIAL

In steel fabrication such as shipbuilding or heavy equipment manufacturing, weld flux chisels are used to clean slag off of welds.

Foundries use these to clean fins (excess metal) on castings.

CONSTRUCTION

Weld flux chisels are used for maintenance and repair of bridges, with rust removal being done by either chisels or needle scalers.

1301 Retainer



371 Driver / Anvil



1302 Retainer Buffer



373 Driver / Anvil



1303 Retainer Clip



374 Driver / Anvil



Bulk Needles

Cat. No.	Diam.	Length	Point Style	Min. Qty.
368	1/8"	4"	FLAT	500
369	2 mm	7"	FLAT	500
376	1/8"	5"	FLAT	500
377	1/8"	7"	FLAT	500
379	3 mm	7"	FLAT	500

Individual Needles

Cat. No.	Diam.	Length	Point Style
5521	3 mm	7"	CHISEL TIP
5522	4 mm	7"	FLAT
5523	4 mm	7"	CHISEL TIP
5525	3 mm	7"	FLAT (Beryllium Copper)

Needle Sets

Cat. No.	Diam.	Length	Qty. per Set	Point Style
1368	1/8"	4"	11	FLAT
1369	2 mm	7"	19	FLAT
1376	1/8"	5"	19	FLAT
1377	1/8"	7"	19	FLAT
1379	3 mm	7"	19	FLAT
1379-12	3 mm	7"	12	FLAT
1379-23	3 mm	7"	23	FLAT
1379-28	3 mm	7"	28	FLAT

Mfg'r	Part No.	Description	Cat. No.
B&D	51700	Needle Set (19)	1376
C.P.T.	P117630	Tube	1380
	WP123818	Buffer	1302
	WP123819	Retainer	1301
	WP123820	Retainer Clip	1303
	P100144	Anvil	374
	P100145	Holder	375
	P100146	Needle Set (19)	1377
	NP123901	Needle Set (12)	1379-12
	NP123902	Needle Set (23)	1379-23
	NP123904	Needle Set (28)	1379-28
Cleco	832956	Retainer	1301
	833527	Buffer	1302
	832554	Retainer Clip	1303
	834045	Driver	373
	834046	Holder	375
	834043	Needle Set (19) 5"	1376
	834779	Tube	1370
	834044	Spring	1371
	834024	Needle Set (19) 7"	1377
I-R	NS11-20	Driver (03328093)	371
	NS11-21	Holder (03328101)	375
	NS1-24	Tube (03043676)	1380
	NS11-22	Needle (19)	1376
	NS11-122	Needle (19) 7"	1377
	NS1-27	Spring (03043718)	1381
Sioux	2260	Needle Set (19)	1376
	54195	Holder	375
	54213	Driver	371
Stanley	P3053	Driver	371
	P3054	Holder	375
	P3055	Needle Set (19)	1376



Non-Collar Chipping Hammer Chisels

.680 ROUND SHANK

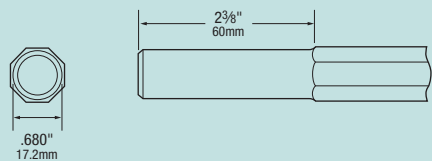

.580 HEX SHANK

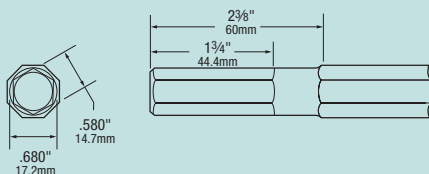

.680 ROUND SHANK					.580 HEX SHANK				
CAT.NO.	STOCK SIZE	LENGTH	WIDTH	WT	CAT.NO.	STOCK SIZE	LENGTH	WIDTH	WT
1	3/4"	8"	—	1 lb.	2	3/4"	8"	—	1 lb.
1-12	3/4"	12"	—	1.4 lb.	2-12	3/4"	12"	—	1.4 lb.
1-18	3/4"	18"	—	2.3 lb.	2-18	3/4"	18"	—	2.3 lb.
1-24	3/4"	24"	—	3 lb.	2-24	3/4"	24"	—	3 lb.
1-36	3/4"	36"	—	4.75 lb.	2-36	3/4"	36"	—	4.75 lb.
1-48	3/4"	48"	—	6.25 lb.	2-48	3/4"	48"	—	6.25 lb.
3	7/8"	8"	—	1.5 lb.	4	7/8"	8"	—	1.5 lb.
3-12	7/8"	12"	—	2 lb.	4-12	7/8"	12"	—	2 lb.
3-18	7/8"	18"	—	3 lb.	4-18	7/8"	18"	—	3 lb.
3-24	7/8"	24"	—	4.25 lb.	4-24	7/8"	24"	—	4.25 lb.
3-36	7/8"	36"	—	6.5 lb.	4-36	7/8"	36"	—	6.5 lb.
3-48	7/8"	48"	—	8.75 lb.	4-48	7/8"	48"	—	8.75 lb.
91	3/4"	9"	—	1 lb.	92	3/4"	9"	—	1 lb.
93	3/4"	12"	—	1.4 lb.	94	3/4"	12"	—	1.4 lb.
95	7/8"	9"	—	1.5 lb.	96	7/8"	9"	—	1.5 lb.
97	7/8"	12"	—	2 lb.	98	7/8"	12"	—	2 lb.
11	3/4"	9"	7/8"	1 lb.	12	3/4"	9"	3/4"	1 lb.
11-12	3/4"	12"	7/8"	1.5 lb.	12-12	3/4"	12"	3/4"	1 lb.
11-18	3/4"	18"	7/8"	2.3 lb.	12-18	3/4"	18"	3/4"	1 lb.
11-24	3/4"	24"	7/8"	3 lb.	12-24	3/4"	24"	3/4"	1 lb.
11-36	3/4"	36"	7/8"	4.75 lb.	12-36	3/4"	36"	3/4"	1 lb.
11-48	3/4"	48"	7/8"	6.25 lb.	12-48	3/4"	48"	3/4"	1 lb.
11-60	3/4"	60"	7/8"	8 lb.	12-60	3/4"	60"	3/4"	1 lb.
11-72	3/4"	72"	7/8"	9.5 lb.	12-72	3/4"	72"	3/4"	1 lb.
13	7/8"	9"	1"	1 lb.	14	7/8"	9"	1"	1 lb.
13-12	7/8"	12"	1"	2 lb.	14-12	7/8"	12"	1"	1 lb.
13-18	7/8"	18"	1"	3 lb.	14-18	7/8"	18"	1"	1 lb.
13-24	7/8"	24"	1"	4.25 lb.	14-24	7/8"	24"	1"	1 lb.
13-36	7/8"	36"	1"	6.5 lb.	14-36	7/8"	36"	1"	1 lb.
13-48	7/8"	48"	1"	8.75 lb.	14-48	7/8"	48"	1"	1 lb.
13-60	7/8"	60"	1"	11 lb.	14-60	7/8"	60"	1"	1 lb.
13-72	7/8"	72"	1"	13 lb.	14-72	7/8"	72"	1"	1 lb.
25	3/4"	9"	2"	1.1 lb.	26	3/4"	9"	2"	1.1 lb.
25-12	3/4"	12"	2"	1.6 lb.	26-12	3/4"	12"	2"	1.6 lb.
25-18	3/4"	18"	2"	2.5 lb.	26-18	3/4"	18"	2"	2.5 lb.
27	7/8"	9"	2"	1.7 lb.	28	7/8"	9"	2"	1.7 lb.
27-12	7/8"	12"	2"	2.1 lb.	28-12	7/8"	12"	2"	2.1 lb.
27-18	7/8"	18"	2"	3.25 lb.	28-18	7/8"	18"	2"	3.25 lb.
35	3/4"	9"	1 1/8"	1 lb.	36	3/4"	9"	1 1/8"	1 lb.
37	7/8"	9"	1 1/8"	1.5 lb.	40	7/8"	9"	1 1/8"	1.5 lb.
21	3/4"	9"	7/16"	1 lb.	22	3/4"	9"	7/16"	1 lb.
23	7/8"	9"	7/16"	1.5 lb.	24	7/8"	9"	7/16"	1.5 lb.
31	3/4"	9"	3/8"	1 lb.	32	3/4"	9"	3/8"	1 lb.
33	7/8"	9"	3/8"	1.5 lb.	34	7/8"	9"	3/8"	1.5 lb.
41	3/4"	9"	5/16"	1 lb.	42	3/4"	9"	5/16"	1 lb.
43	7/8"	9"	5/16"	1.5 lb.	44	7/8"	9"	5/16"	1.5 lb.
51	3/4"	9"	1"	1 lb.	52	3/4"	9"	1"	1 lb.
53	7/8"	9"	1"	1.5 lb.	54	7/8"	9"	1"	1.5 lb.

POINT STYLE

Blank

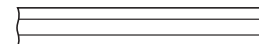

Moil Point

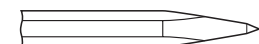

Flat Chisel



Scaling Chisel

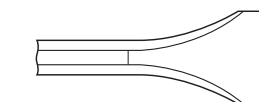

Thin Blade Flat

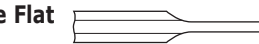

Cape Chisel



Round Nose



Diamond Point

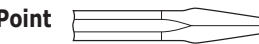

Gouge

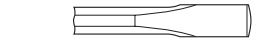

NOTE: Pneumatic Chipping Hammers are equipped with either .680 round nose bushings or .580 hex nose bushings. Refer to manufacturer's hammer model number for specifications.



1-800-323-9129



1-800-424-AJAX



ajaxtools.com

15

AJAX Tools

Oval Collar Chipping Hammer Chisels



.680 ROUND SHANK OVAL COLLAR

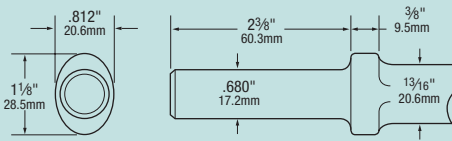

.580 HEX SHANK OVAL COLLAR

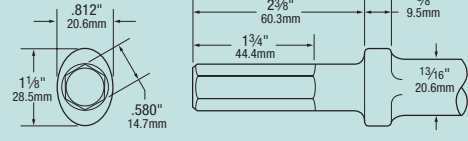

POINT STYLE

Round Blank



CAT.NO.	LENGTH	WIDTH	WT	CAT.NO.	LENGTH	WIDTH	WT
301	8 1/4"	13/16" Dia.	1.25 lbs.	302	8 1/4"	13/16" Dia.	1.25 lbs.
301-12	11 1/4"	13/16" Dia.	1.5 lbs.	302-12	11 1/4"	13/16" Dia.	1.5 lbs.
301-18	18"	13/16" Dia.	2.5 lbs.	302-18	18"	13/16" Dia.	2.5 lbs.
301-24	24"	13/16" Dia.	3.25 lbs.	302-24	24"	13/16" Dia.	3.25 lbs.

Moil Point

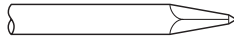

313	9"	—	1.25 lbs.	314	9"	—	1.25 lbs.
315	12"	—	1.5 lbs.	316	12"	—	1.5 lbs.
315-18	18"	—	2.5 lbs.	316-18	18"	—	2.5 lbs.
315-24	24"	—	3.25 lbs.	316-24	24"	—	3.25 lbs.

Flat Chisel

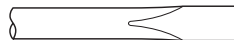

303	9"	1"	1.25 lbs.	304	9"	1"	1.25 lbs.
303-12	12"	1"	1.5 lbs.	304-12	12"	1"	1.5 lbs.
303-18	18"	1"	2.5 lbs.	304-18	18"	1"	2.5 lbs.
303-24	24"	1"	3.25 lbs.	304-24	24"	1"	3.25 lbs.
303-36	36"	1"	5.1 lbs.	304-36	36"	1"	5.1 lbs.
303-48	48"	1"	6.9 lbs.	304-48	48"	1"	6.9 lbs.
303-60	60"	1"	8.7 lbs.	304-60	60"	1"	8.7 lbs.
303-72	72"	1"	10.2 lbs.	304-72	72"	1"	10.2 lbs.

Scaling Chisel

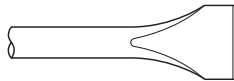

325	9"	1 1/2"	1.25 lbs.	326	9"	1 1/2"	1.25 lbs.
325-12	12"	1 1/2"	1.5 lbs.	326-12	12"	1 1/2"	1.5 lbs.
325-18	18"	1 1/2"	2.5 lbs.	326-18	18"	1 1/2"	2.5 lbs.
323	9"	2"	1.25 lbs.	324	9"	2"	1.25 lbs.
323-12	12"	2"	1.75 lbs.	324-12	12"	2"	1.75 lbs.
323-18	18"	2"	2.75 lbs.	324-18	18"	2"	2.75 lbs.
323-24	24"	2"	3.75 lbs.	324-24	24"	2"	3.75 lbs.
323-36	36"	2"	5.75 lbs.	324-36	36"	2"	5.75 lbs.
323-48	48"	2"	7.75 lbs.	324-48	48"	2"	7.75 lbs.
323-60	60"	2"	9.75 lbs.	324-60	60"	2"	9.75 lbs.
323-72	72"	2"	11.75 lbs.	324-72	72"	2"	11.75 lbs.
323-3	9"	3"	1.5 lbs.	324-3	9"	3"	1.5 lbs.
323-12-3	12"	3"	1.75 lbs.	324-12-3	12"	3"	1.75 lbs.
323-4-1/2	10"	4 1/2"	2.25 lbs.	324-4-1/2	10"	4 1/2"	2.25 lbs.

Ripper

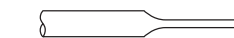

311	9"	1 1/16"	1.0 lbs.	312	9"	1 1/16"	1.0 lbs.
311-12	12"	1 1/16"	1.4 lbs.	312-12	12"	1 1/16"	1.4 lbs.

Cape Chisel



305	9"	7/16"	1.0 lbs.	306	9"	7/16"	1.0 lbs.
305-12	12"	7/16"	1.4 lbs.	306-12	12"	7/16"	1.4 lbs.

Round Nose



307	9"	3/8"	1.0 lbs.	308	9"	3/8"	1.0 lbs.
307-12	12"	3/8"	1.4 lbs.	308-12	12"	3/8"	1.4 lbs.

Diamond Point

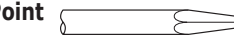

309	9"	5/16"	1.1 lbs.	310	9"	5/16"	1.1 lbs.
309-12	12"	5/16"	1.5 lbs.	310-12	12"	5/16"	1.5 lbs.

Gouge

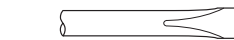

337	9"	1"	1.1 lbs.	338	9"	1"	1.1 lbs.
337-12	12"	1"	1.5 lbs.	338-12	12"	1"	1.5 lbs.

2 Pc. Bush Tool



343	9 1/2"		2.25 lbs.	344	9 1/2"		2.25 lbs.
345 STEM	8"		1.0 lbs.	346 STEM	8"		1.0 lbs.
5101 HEAD	—	1 1/2" SQ	1.25 lbs.	5101 HEAD	—	1 1/2" SQ	1.25 lbs.

1 Pc. Bush Tool



50100	9 1/2"	1 3/4" SQ	2.5 lbs.	50200	9 1/2"	1 3/4" SQ	2.5 lbs.
-------	--------	-----------	----------	-------	--------	-----------	----------

NOTE: Pneumatic Chipping Hammers are equipped with either .680 round nose bushings or .580 hex nose bushings. Refer to manufacturer's hammer model number for specifications.

Round Collar Chipping Hammer Chisels

.680 ROUND SHANK ROUND COLLAR

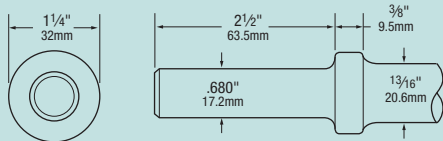

.580 HEX SHANK ROUND COLLAR

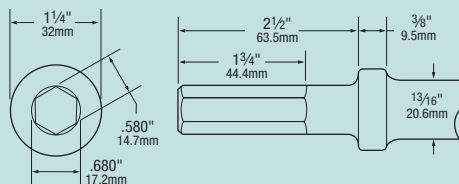

CAT.NO.	LENGTH	WIDTH	WT	CAT.NO.	LENGTH	WIDTH	WT
401	8 1/4"	13/16" Dia.	1.25 lbs	402	8 1/4"	13/16" Dia.	1.25 lbs
403	11 1/4"	13/16" Dia.	1.5 lbs	404	11 1/4"	13/16" Dia.	1.5 lbs
403-18	18"	13/16" Dia.	2.5 lbs	404-18	18"	13/16" Dia.	2.5 lbs
409	9"	—	1.25 lbs	410	9"	—	1.25 lbs
411	12"	—	1.5 lbs	412	12"	—	1.5 lbs
411-18	18"	—	2.5 lbs	412-18	18"	—	2.5 lbs
411-24	24"	—	3.25 lbs	412-24	24"	—	3.25 lbs
405	9"	1"	1.25 lbs	406	9"	1"	1.25 lbs
407	12"	1"	1.5 lbs	408	12"	1"	1.5 lbs
407-18	18"	1"	2.5 lbs	408-18	18"	1"	2.5 lbs
407-24	24"	1"	3.25 lbs	408-24	24"	1"	3.25 lbs
407-36	36"	1"	5 lbs	408-36	36"	1"	5 lbs
407-48	48"	1"	6 lbs	408-48	48"	1"	6 lbs
407-60	60"	1"	8 lbs	408-60	60"	1"	8 lbs
407-72	72"	1"	10 lbs	408-72	72"	1"	10 lbs
425	9"	1 1/2"	1.25 lbs	426	9"	1 1/2"	1.25 lbs
425-12	12"	1 1/2"	1.5 lbs	426-12	12"	1 1/2"	1.5 lbs
425-18	18"	1 1/2"	2.5 lbs	426-18	18"	1 1/2"	2.5 lbs
423	9"	2"	1.25 lbs	424	9"	2"	1.25 lbs
423-12	12"	2"	1.75 lbs	424-12	12"	2"	1.75 lbs
423-18	18"	2"	2.75 lbs	424-18	18"	2"	2.75 lbs
423-24	24"	2"	3.75 lbs	424-24	24"	2"	3.75 lbs
423-36	36"	2"	5.75 lbs	424-36	36"	2"	5.75 lbs
423-48	48"	2"	7.75 lbs	424-48	48"	2"	7.75 lbs
423-60	60"	2"	9.75 lbs	424-60	60"	2"	9.75 lbs
423-72	72"	2"	11.75 lbs	424-72	72"	2"	11.75 lbs
423-3	9"	3"	1.5 lbs	424-3	9"	3"	1.5 lbs
423-12-3	12"	3"	1.75 lbs	424-12-3	12"	3"	1.75 lbs
423-4-1/2	10"	4 1/2"	2.25 lbs	424-4-1/2	10"	4 1/2"	2.25 lbs
413	9"	7/16"	1.0 lbs	414	9"	7/16"	1.0 lbs
413-12	12"	7/16"	1.4 lbs	414-12	12"	7/16"	1.4 lbs
417	9"	3/8"	1.0 lbs	418	9"	3/8"	1.0 lbs
417-12	12"	3/8"	1.4 lbs	418-12	12"	3/8"	1.4 lbs
419	9"	5/16"	1.1 lbs	420	9"	5/16"	1.1 lbs
419-12	12"	5/16"	1.5 lbs	420-12	12"	5/16"	1.5 lbs
437	9"	1"	1.1 lbs	438	9"	1"	1.1 lbs
437-12	12"	1"	1.5 lbs	438-12	12"	1"	1.5 lbs
443	9 1/2"	—	2.25 lbs	444	9 1/2"	—	2.25 lbs
445 STEM	8"	—	1.0 lbs	446 STEM	8"	—	1.0 lbs
5101 HEAD	—	1 1/2" SQ	1.25 lbs	5101 HEAD	—	1 1/2" SQ	1.25 lbs
50300	9 1/2"	1 3/4" SQ	2.5 lbs	50400	9 1/2"	1 3/4" SQ	2.5 lbs
429	16 3/4"	7/8"	2.1 lbs				
431	18 1/4"	7/8"	2.2 lbs				
433	16 3/4"	7/8"	2.1 lbs				
435	18 1/4"	7/8"	2.2 lbs				

POINT STYLE

Round Blank



Moil Point

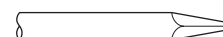

Flat Chisel

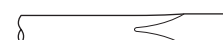

Scaling Chisel

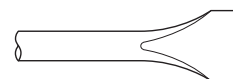

Cape Chisel



Round Nose



Diamond Point



Gouge

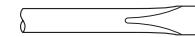

2 Pc. Bush Tool

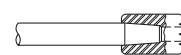

1 Pc. Bush Tool



Paper Stripper

Bent



Straight



Chipping Hammer Retainers

INTERNAL PARTS FOR NO. 3750

1472 (H3R-31) Washer (2 pc.) Upper



1473 (H3R-203) Bumper



1474 (HHW1-213) Washer (2 pc.) Lower

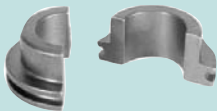

1475 (HHW1-216) Retainer Ring



1476 (24SR-207) Lock Spring
(AT1191-8) Also fits Retainer #3450



RETAINER SPRINGS

300 Heavy Duty Lock Spring
(AT No. 1194)

Fits retainers #3400 and #4000
No. 300-P (pkg. of 100 pcs.)



350 Standard Duty Lock Spring

Fits retainers #3400 and #4000
No. 350-P (pkg. of 100 pcs.)



400 "The Ringer"

Made of 8000 PSI Polyurethane
Fits retainers #3400 and #4000
No. 400-P (pkg. of 100 PCS.)



WARNING:
Wear Safety
Goggles



AJAX Kwik Change Retainer
Accepts Both Oval or Round Collar Tools

- Kwik Change feature allows easy removal/replacement of tool
- Six steel balls hold tool securely in place
- Any width tool can be inserted
- Uses No. 300 heavy-duty spring supplied with unit

*See page 19 for ordering information.

3400 Retainer



REPLACEMENT PARTS FOR #3400

- 300 Lock Spring
 - 3404 Snap Washer
 - 3401* Body
 - 3405* "O" ring
 - 3402 Sleeve
 - 3406 Balls (6 per set)
 - 3403 Spring
- *Specify hammer manufacturer and model number

REPLACEMENT PARTS FOR #3450

- 1476 Lock Spring
- 3450-3 Spring
- 3450-1 Body
- 3404 Snap Washer
- 3450-2 Sleeve
- 3406 Balls (6 per set)

All the advantages of our No. 3400, now available for hammers with threaded barrels. Uses No. 1476 lock spring, supplied with unit.

3450 Threaded Retainer



3750 Threaded Solid Retainer

FOR USE WITH ROUND COLLAR TOOLS ONLY

Can be used on hammers with threaded barrels. Retainer must be removed from tool to change chisels. Supplied with No. 1476 lock spring.

Interchangeable with: (AT No. 1198) (I-R No. HHWI-300)



4000 Solid Retainer

FOR USE WITH OVAL COLLAR TOOLS ONLY

Fits hammers with tapered barrels. Supplied with No. 350 standard-duty lock spring.

Interchangeable with: (AT No. 1190)

*See page 19 for ordering information.



Chipping Hammer Retainers

	MODEL	3400 ORDER	3450 ORDER	3750 ORDER	4000 ORDER
AMER. PNEUMATIC	500-600	3400-3			4000-3
AMER. PNEUMATIC	550-650	3400-5			4000-5
AMER. PNEUMATIC	106	3400-12			4000-12
AMER. PNEUMATIC	520-620 SERIES (THREADED)		3450	3750	
ATLAS COPCO	317, 317D, 319, 419	3400-2			4000-2
A.T.P. -HY-TECH	ATP-2HB, ATP-3HB, ATP-4HB	3400-2			4000-2
ATSCO	ALL MODELS	3400-3			4000-3
CHICAGO PNEUMATIC	RV-0-1-2-3-4, CP4234	3400-1			4000-1
CHICAGO PNEUMATIC	SIMPLATE 1-2-3-4, CP4123	3400-2			4000-3
CHICAGO PNEUMATIC	BOYER 1-2-3-4	3400-5			4000-5
CHICAGO PNEUMATIC	9362-9363-9364	3400-2			4000-2
CLECO	1WM-2WM-3WM-C20B-C30B	3400-5			4000-5
CLECO	C20-C30	3400-8			4000-8
CLECO	2WA-3WA-2WAM-3WAM	3400-13			4000-13
CLECO	CL3-OWBD	3400-20			4000-20
CLECO	CH-22, CH-32	3400-5			4000-5
CONTINENTAL POWER TOOL	CH-1A-2A-3A-4A	3400-2			4000-2
GARDNER DENVER	CH3 SERIES	3400-14			4000-14
INGERSOLL-RAND	1-2-200-2A-3-300-3A-4-400	3400-3			4000-3
INGERSOLL-RAND	K2L	3400-12			4000-12
INGERSOLL-RAND	W-SERIES (THREADED)		3450	3750	
JET	JCO SERIES	3400-2			4000-2
KENT	RED LINE KC 1-2-3-4	3400-17			4000-17
KENT	RED LINE KJ 1-2-3-4 (KCB)	3400-2			4000-2
KENT	GREEN LINE 1-2-3-4	3400-17			4000-17
MASTER POWER	1, 2E, 3E, 4	3400-10			4000-10
MICHIGAN PNEUMATIC	ALL MODELS	3400-2			4000-2
SULLAIR	SCH-2-3-4	3400-2			4000-2
SULLAIR	MCH-2-3-4	3400-2			4000-2
SULLIVAN	SCH-2-3-4	3400-2			4000-2
SULLIVAN	SCH-01-02-03-04	3400-2			4000-2
SULLIVAN	SCH-11	3400-5			4000-5
TC SERVICE	10-20-30-40	3400-17			4000-17
THOR	00-11-22-33-CH3	3400-5			4000-5
UNIVERSAL TOOL	8600 SERIES	3400-2			4000-2
URYU	ALL MODELS	3400-18			4000-18
U.S. INDUSTRIAL	502TB-503TB-5045B (THREADED)		3450	3750	

HOSE SWIVELS

For most chipping hammers, as well as larger tools having 1/2" pipe threads.

Swivels eliminate hose kinking or twisting and provide greater operator efficiency.



- 1060* 1/2" Pipe Thread Hose Swivel
- 1061 Body
- 1063 Snap Ring
- 1062 Nut
- 1082 "O" ring



- 1090* 7/8"-20 Thread Hose Swivel
- 1081 Body
- 1084 Snap Ring
- 1091 Nut
- 1082 "O" ring



- 1080* 7/8"-24 Thread Hose Swivel
- 1081 Body
- 1084 Snap Ring
- 1083 Nut
- 1082 "O" ring



- 1092 7/8"-24 Thread with 3/8 NPT Hose Swivel
- 1093 Body
- 1084 Snap Ring
- 1083 Nut
- 1082 "O" ring

*NOTE: 1/2" hose barb on 1060, 1080 and 1090



Beryllium Copper Safety Tools

WEDGES

For use in chemical and oil refinery applications.



875-BC Flange Wedge
7/8" x 7/8" x 11"



876-BC Banana Wedge
13/16" x 13/16" x 12"

- NON-SPARKING
- NON-MAGNETIC

- FOR USE WHERE FLAMMABLE VAPORS OR RESIDUE ARE PRESENT.

295-BC Ripper Chisel Jumbo Shank

9 1/2" OAL
For Rivet Hammers

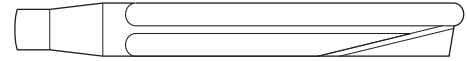

323-BC Chisel

.680 Round Shank Oval Collar, 2 1/2" x 10"
For Chipping Hammers

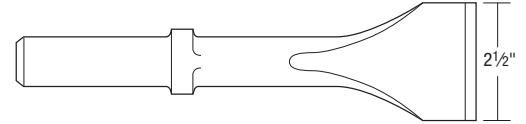

380-BC Chisel

2" x 8" OAL
For use in most Scaling Hammers



390-BC Chisel

2" x 7" OAL
For use in most Cleco-Roto-Aro Scalers

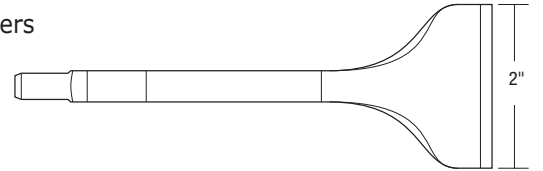

909-BC Panel Cutter

6" OAL
For use in .401 Air Hammers



910-2-BC Chisel

2" x 7" OAL
For use in .401 Air Hammers



3221-BC Panel Cutter

6 1/2" OAL
For use in most Scaling Hammers

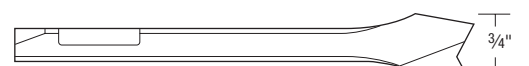

WARNING:
Wear Safety
Goggles



Rivet Buster Tools

STANDARD SHANK

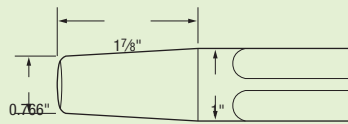

JUMBO SHANK

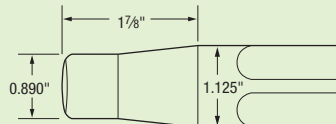

CAT.NO.	LENGTH	WIDTH	WT.	CAT.NO.	LENGTH	WIDTH	WT.		
245	9"	—	1.5 lbs.	296	10"	—	2 lbs.		
246	12"	—	2.1 lbs.	297	12"	—	2.5 lbs.		
246-18	18"	—	2.5 lbs.	297-18	18"	—	3.9 lbs.		
				297-24	24"	—	4.6 lbs.		
221	9"	7/8"	1.5 lbs.	276	9 1/2"	15/16"	1.9 lbs.		
221-12	12"	7/8"	2.1 lbs.	276C	9 1/2"	15/16"	1.9 lbs.		
221-18	18"	7/8"	3.2 lbs.	276-12	12"	15/16"	2.5 lbs.		
				276-12C	12"	15/16"	2.5 lbs.		
				276-18	18"	15/16"	3.9 lbs.		
				276-18C	18"	15/16"	3.9 lbs.		
				276-24	24"	15/16"	4.6 lbs.		
				Note: Jumbo flat chisels marked "C" are carbon steel for concrete.					
222	9"	7/8"	1.5 lbs.	277	9 1/2"	15/16"	2 lbs.		
				276-12-2	12"	2"	3.25 lbs.		
				Note: Use Ajax No. 274-S Split Lower Sleeve with 2" Chisels.					
CAT.NO.	LENGTH	RIVET SIZE	WT.	CAT.NO.	LENGTH	RIVET SIZE	WT.		
223	9"	3/8"	1.3 lbs.	278	9 1/2"	3/8"	1.5 lbs.		
224	9"	1/2"	1.4 lbs.	279	9 1/2"	1/2"	1.7 lbs.		
225	9"	5/8"	1.5 lbs.	280	9 1/2"	5/8"	1.8 lbs.		
226	9"	3/4"	1.6 lbs.	281	9 1/2"	3/4"	1.9 lbs.		
227	9"	7/8"	1.6 lbs.	282	9 1/2"	7/8"	1.9 lbs.		
228	9"	1"	1.7 lbs.	283	9 1/2"	1"	2 lbs.		
				284	9 1/2"	1 1/8"	2 lbs.		
CAT.NO.	LENGTH	RIVET SIZE	CLEARANCE	WT.	CAT.NO.	LENGTH	RIVET SIZE	CLEARANCE	WT.
231	9 1/2"	5/8"	4"	1.3 lbs.	285	10"	5/8"	4"	1.7 lbs.
232	11 1/2"	5/8"	6"	1.4 lbs.	286	12"	5/8"	6"	1.8 lbs.
233	13 1/2"	5/8"	8"	1.7 lbs.	287	14"	5/8"	8"	1.9 lbs.
234	9 1/2"	3/4"	4"	1.5 lbs.	288	10"	3/4"	4"	1.8 lbs.
235	11 1/2"	3/4"	6"	1.7 lbs.	289	12"	3/4"	6"	2 lbs.
236	13 1/2"	3/4"	8"	1.9 lbs.	290	14"	3/4"	8"	2.3 lbs.
237	9 1/2"	7/8"	4"	1.8 lbs.	291	10"	7/8"	4"	2 lbs.
238	11 1/2"	7/8"	6"	2.1 lbs.	292	12"	7/8"	6"	2.2 lbs.
239	13 1/2"	7/8"	8"	2.3 lbs.	293	14"	7/8"	8"	2.7 lbs.
CAT.NO.	LENGTH	WIDTH	WT.	CAT.NO.	LENGTH	WIDTH	WT.		
241	9"	—	1.6 lbs.	295	9 1/2"	—	1.6 lbs.		
				298	7 1/2"	—	1.6 lbs.		



POINT STYLE

Moil Point



Flat Chisel



Flat Side Cut Chisel

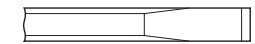

Flat 2" Wide Chisel

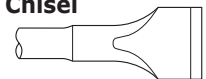

Back Out Punch



Long Clearance Back Out Punch



Ripper



Drift Pin



Exchanger Tube Back Out Punch



240 Standard Shank

Furnished for 1/2" (13mm), 5/8" (16mm), 3/4" (19mm), 7/8" (22mm), 1" (25mm), 1 1/8" (29mm), and 1 1/4" (32mm) dia. tubes.

294 Jumbo Shank

Furnished for various gauge tubes as may be specified. Furnished with 4" (102mm), 6" (152mm) or 8" (203mm) clearance.

Tube size is maintained immediately next to Shearing Point, balance of clearance length is relieved by grinding to .020" (.50mm) under tube size to eliminate binding.

Pilot diameter varies to comply with gauge and inside diameter of tube.

Please specify size and gauge of tube and length of clearance wanted.

i.e. 294-3/4x12x8

NOTE: Other shank styles available on request.



1-800-323-9129



1-800-424-AJAX



ajaxtools.com

Rivet Buster Accessories



215 Rubber Bumper for Standard Tools

#215-P = Pkg. of 50 pcs.



275 Rubber Bumper for Jumbo Tools

#275-P = Pkg. of 50 pcs.



275-PBJ Polyester Bumper for Jumbo Tools with harder finish for long life



206 Lock Spring

#206-P = Pkg. of 100 pcs.

NOTE: Ajax No. 214-S and Ajax No. 274-S Split Lower Sleeves available for use with Extra Wide Chisels and Punches.

Upper Sleeves

211	Upper Sleeve for Standard Tools	
212	Upper Sleeve for Standard Tools #212-P = Pkg. of 50 pcs.	
212-J	Upper Sleeve for Jumbo Tools This sleeve used in standard buster with jumbo tools.	
213	Upper Sleeve for Standard Tools	
262	Upper Sleeve for Jumbo Tools Fits C.P.T. #4181 Model "V" Type	
270	Upper Sleeve for Jumbo Tools	
271	Upper Sleeve for Jumbo Tools	
272	Upper Sleeve for Jumbo Tools #272-P = Pkg. of 50 pcs.	
272-4	Upper Sleeve (These sleeves are used in Jumbo Buster with Standard Tools)	

Lower Sleeves

214	Lower Sleeve for Standard Tools #214-P = Pkg. of 50 pcs.	
214-900	Lower Sleeve for Standard Tools	
273	Lower Sleeve for Jumbo Tools This sleeve used in standard buster with jumbo tools.	
274	Lower Sleeve for Jumbo Tools #274-P = Pkg. of 50 pcs.	
274-4	Lower Sleeve (These sleeves are used in Jumbo Buster with Standard Tools)	

Retainers

205		207	
208		209	

WARNING:
Wear Safety Goggles



Rivet Buster Accessories



Rivet Buster Retainer & Sleeve Alignment

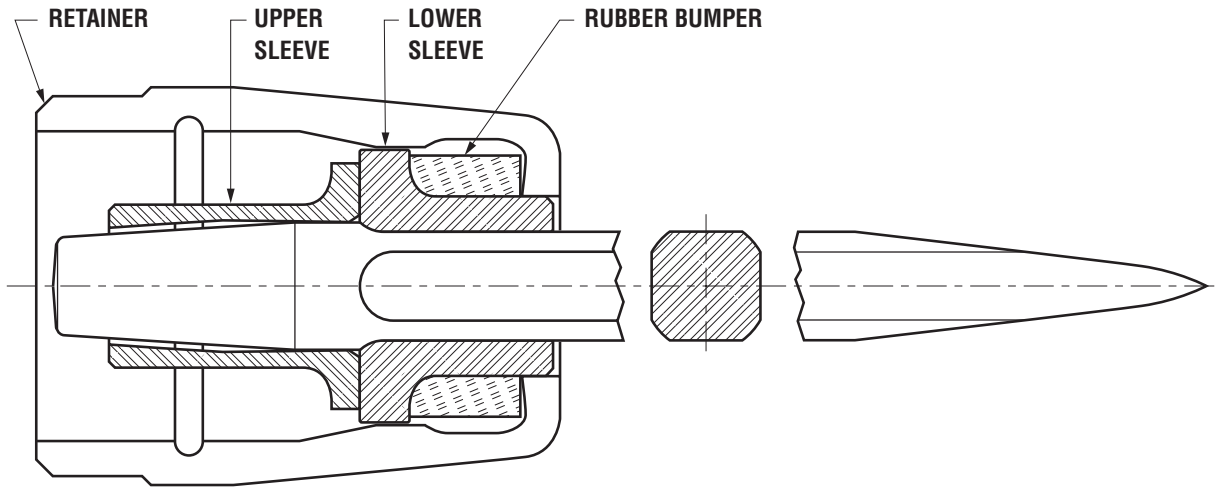

RETAINERS, SLEEVES & BUMPERS SPECIFICATION CHART

HAMMER MANUFACTURER	MODEL #	RETAINER CAT. #	RETAINER INSIDE DIA.	UPPER SLEEVE	LOWER SLEEVE	BUMPER	SHANK TYPE
AMERICAN PNEUMATIC	133	208	2.610	272	274	275	JUMBO
ATLAS COPCO TOOLS	TEX-830,TEX-1133	207	2.570	272	274	275	JUMBO
ATSCO	RB-08, RB-11	208	2.610	272	274	275	JUMBO
CHICAGO PNEUMATIC TOOL	BOYER 50, 60, 80, 80X, 90	205-2.445	2.445	212	214	215	STANDARD
CHICAGO PNEUMATIC TOOL	BOYER NO. 11*	209	2.445	271	274	275	JUMBO
CHICAGO PNEUMATIC TOOL	BOYER NO. 11*	209	2.445	270	274	275	JUMBO
CHICAGO PNEUMATIC TOOL	4181, 81X, 11X	207	2.570	272	274	275	JUMBO
CONTINENTAL AIR TOOLS	CRB-8, CRB-11	205-2.445	2.445	272	274	275	JUMBO
INGERSOLL RAND	8001A	207	2.570	272	274	275	JUMBO
INGERSOLL RAND	9001	N/A		272	274	275	JUMBO
JET EQUIPMENT	RB90	N/A		212	214	215	STANDARD
JET EQUIPMENT	RB91	N/A		212-J	273	215	JUMBO
KAISER	KRB-8, KRB-11	208	2.610	272	274	275	JUMBO
KENT	K-800, K-1100	205-2.445	2.445	272	274	275	JUMBO
MCDONALD	DM12	N/A		272	274	275	JUMBO
SULLAIR	MRB-8, MRB-11	205-2.445	2.445	272	274	275	JUMBO
SULLIVAN	SRB-8, SRB-11	208	2.610	272	274	275	JUMBO
THOR	50, 53, 60, 63, 80, 83, 90, 93	205-2.385	2.385	211	214	214	STANDARD
THOR	50, 53, 60, 63, 80, 83, 90, 93	205-2.385	2.385	270	273	215	JUMBO
THOR	RB-08, RB-11	208	2.610	272	274	275	JUMBO

NOTE: *Chicago Pneumatic Boyer No. 11 uses either #271 upper sleeve with special Parker taper or #270 upper sleeve with 111/32" straight shank. Please check your hammer.

WARNING:
Wear Safety
Goggles



Paving Breaker Tools

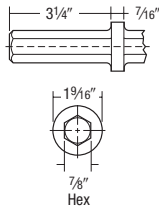

7/8" X 3 1/4"

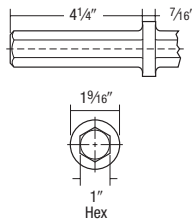

1" X 4 1/4"

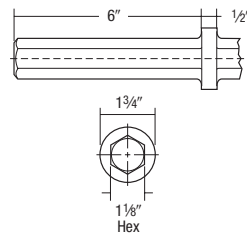

1 1/8" X 6"

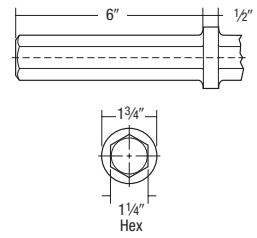

1 1/4" X 6"

POINT STYLE

Standard Moil Point

General concrete demolition

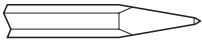

CAT.NO.	LGTH. U.C.	WT.	CAT.NO.	LGTH. U.C.	WT.	CAT.NO.	LGTH. U.C.	WT.	CAT.NO.	LGTH. U.C.	WT.
11200	14"	3 1/4 lbs	21200	14"	4 3/4 lbs	31200	14"	6 lbs	41200	14"	7 1/4 lbs
12200	18"	4 lbs	22200	18"	5 1/4 lbs	32200	18"	7 1/4 lbs	42200	18"	9 lbs
13200	24"	4 3/4 lbs	23200	24"	6 3/4 lbs	33200	24"	9 lbs	43200	24"	11 lbs
14200	36"	6 1/4 lbs	24200	36"	8 3/4 lbs	34200	36"	12 1/2 lbs	44200	36"	15 3/4 lbs
			25200	48"	13 lbs	35200	48"	16 lbs	45200	48"	20 1/4 lbs
			26200	60"	15 1/2 lbs	36200	60"	20 lbs	46200	60"	24 3/4 lbs
			27200	72"	19 lbs	37200	72"	24 lbs	47200	72"	30 lbs

Standard Narrow Chisel

General concrete demolition

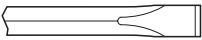

11100	14"	3 1/4 lbs	21100	14"	4 3/4 lbs	31100	14"	6 lbs	41100	14"	7 1/4 lbs
12100	18"	4 lbs	22100	18"	5 1/4 lbs	32100	18"	7 1/4 lbs	42100	18"	9 lbs
13100	24"	4 3/4 lbs	23100	24"	6 3/4 lbs	33100	24"	9 lbs	43100	24"	11 lbs
14100	36"	6 1/4 lbs	24100	36"	8 3/4 lbs	34100	36"	12 1/2 lbs	44100	36"	15 3/4 lbs
			25100	48"	13 lbs	35100	48"	16 lbs	45100	48"	20 1/4 lbs
			26100	60"	15 1/2 lbs	36100	60"	20 lbs	46100	60"	24 3/4 lbs
			27100	72"	19 lbs	37100	72"	24 lbs	47100	72"	30 lbs

Standard 3" Wide Chisel

Cutting pavement overlay, general concrete demolition

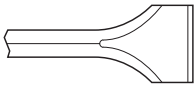

11300	14"	3 1/2 lbs	21300	14"	5 lbs	31300	14"	6 3/4 lbs	41300	14"	8 lbs
12300	18"	4 1/4 lbs	22300	18"	6 lbs	32300	18"	8 lbs	42300	18"	9 1/2 lbs
13300	24"	5 1/2 lbs	23300	24"	7 1/2 lbs	33300	24"	9 1/2 lbs	43300	24"	11 1/2 lbs
14300	36"	8 lbs	24300	36"	10 1/2 lbs	34300	36"	12 3/4 lbs	44300	36"	16 1/4 lbs
			25300	48"	13 1/2 lbs	35300	48"	17 lbs	45300	48"	20 3/4 lbs
			26300	60"	17 lbs	36300	60"	20 3/4 lbs	46300	60"	25 1/4 lbs
			27300	72"	19 1/4 lbs	37300	72"	24 1/2 lbs	47300	72"	30 lbs

Asphalt Cutter

5" x 6" Cutting asphalt, hardpan and compacted soil



18400		6 1/2 lbs	28400		6 1/2 lbs	38400		6 1/2 lbs	48400		8 1/4 lbs
-------	--	-----------	-------	--	-----------	-------	--	-----------	-------	--	-----------

Small Asphalt Cutter

4 1/2" x 3" Cutting asphalt, hardpan and compacted soil

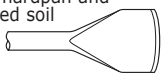

10011		6 1/2 lbs	20011		7 3/4 lbs	30011		7 3/4 lbs	40011		7 3/4 lbs
-------	--	-----------	-------	--	-----------	-------	--	-----------	-------	--	-----------

Clay Spade

Clay and other rock-free soil
5 1/2" x 6 1/2"
• 4 1/2" x 6 1/2"



19500		7 1/4 lbs	29500		8 1/4 lbs	39500		7 3/4 lbs	49500		10 lbs
			29501		7 1/2 lbs	39501		9 lbs	49501		9 3/4 lbs

Used for demolition of concrete in buildings, dams, roadwork. Industrial applications include breaking refractory liners from furnaces and chipping away slag and molten steel from ladles.

NOTE: LGTH. U.C. = Length Under Collar

WARNING:
Wear Safety
Goggles



Paving Breaker Tools

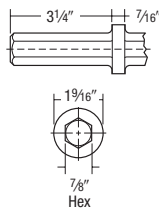

7/8" X 3-1/4"

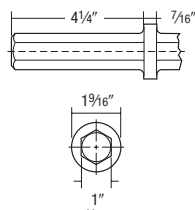

1" X 4-1/4"

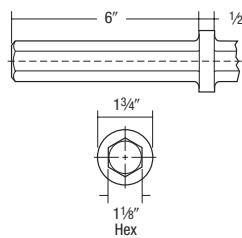

1-1/8" X 6"

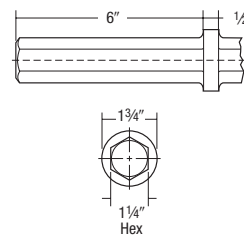

1-1/4" X 6"



CAT.NO.	WT.	CAT.NO.	WT.	CAT.NO.	WT.	CAT.NO.	WT.
18401	9 1/4 lbs	28401	10 lbs	38401	10 1/2 lbs	48401	10 1/2 lbs
11080	6 1/2 lbs	21080	7 lbs	31080	8 1/2 lbs	41080	10 1/4 lbs
11060	8 1/2 lbs	21060	9 lbs	31060	13 lbs	41060	13 lbs
N/A		21140	6 1/2 lbs	31140	8 lbs	41140	8 3/4 lbs
N/A		21130	6 lbs	31130	7 lbs	41130	8 1/4 lbs
10010	6 1/4 lbs	20010	6 1/4 lbs	30010	8 1/4 lbs	40010	8 1/4 lbs
11700	8 3/4 lbs	21700	9 3/4 lbs	31700	10 3/4 lbs	41700	11 1/4 lbs

POINT STYLE

Long Spade 3 Edged
5" x 9" Clay and other rock-free soil

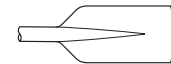

Digging Chisel
3" x 10" Deeper penetration in hardpan, gravel and similar materials



Frost Wedge
1 7/8" x 12" Breaking up frozen ground



Asphalt Wedge
3" x 7" Spitting apart asphalt



Concrete Wedge
1" x 3" Splitting apart concrete

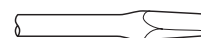

Bushing Tool
2" x 2" Roughing up or surface removal of concrete

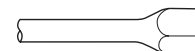

Concrete Breaker
Breaking up concrete after first drilling a hole



CAT.NO.	ROD SIZE	CAT.NO.	HOLE SIZE	ROD SIZE	CAT.NO.	HOLE SIZE	ROD SIZE	CAT.NO.	HOLE SIZE	ROD SIZE
N/A		21758	3/4"	5/8"	31758	3/4"	5/8"	41758	3/4"	5/8"
N/A		21734	7/8"	3/4"	31734	7/8"	3/4"	41734	7/8"	3/4"
N/A		21778	1"	7/8"	31778	1"	7/8"	41778	1"	7/8"
N/A		21701	1 1/8"	1"	31701	1 1/8"	1"	41701	1 1/8"	1"

POINT STYLE

Ground Rod Driver
Driving electrical grounding rods into the soil



Used for demolition of concrete in buildings, dams, roadwork. Industrial applications include breaking refractory liners from furnaces and chipping away slag and molten steel from ladles.

Drill Steel

Roto Hammers

Carbide Utility Bit

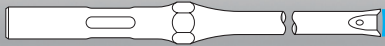

Part No.	Bit Diam.	Drilling Depth	Overall Length
62005	1/2"	8"	12"
62010	5/8"	8"	12"
62020	5/8"	12"	16"
62030	5/8"	18"	22"
62040	3/4"	8"	12"
62050	3/4"	12"	16"
62060	3/4"	18"	22"
62070	7/8"	8"	12"
62080	7/8"	12"	16"
62090	7/8"	18"	22"
62100	1"	8"	12"
62110	1"	12"	16"
62120	1"	18"	22"
62130	1"	24"	28"

Roto Hammer Chisels



Part No.	Point Style	Overall Length
4020	Chisel Blank	9"
4021	Flat Chisel	10"
4025	Moil Point	10"
4027	Mortar Chisel	11"
4028	Slotting Tool	10"
4029	Tooth Chisel	9"
4024	Wood Chisel	12"
4045	Bush Tool Assembly	
4023	Bush Tool Stem	
5101	Bush Tool Head	

Roto Hammer Adaptors



Part No.	Description
4014	New "A" Taper Adapter
4015	Std. "A" Taper Adapter
4016	Std. "B" Taper Adapter
935	Knockout Key for 4014
938	Knockout Key for 4015, 4016

Roto Hammer Chisels, Adaptors and Utility Bits can be used with these models:

Chicago Pneumatic CP-9A
Sullair MRD-9 **Thor** 5LHD

Carbide Speed Bits

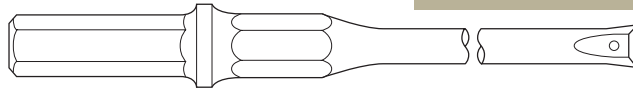

HOLE DIAM.	DRILLING DEPTH	LENGTH UNDER COLLAR	7/8" X 3 1/4"	7/8" X 4 1/4"	1" X 4 1/4"
			HEX SHANK PART NO.	HEX SHANK PART NO.	HEX SHANK PART NO.
5/8"	6"	9"	60010	60350	—
5/8"	9"	14"	60020	60360	—
5/8"	14"	20"	60030	60370	—
3/4"	6"	9"	60040	60380	—
3/4"	9"	14"	60050	60390	—
3/4"	14"	20"	60060	60400	—
3/4"	20"	24"	60070	60410	—
3/4"	26"	30"	60080	60420	—
7/8"	6"	9"	60090	60430	—
7/8"	9"	14"	60100	60440	—
7/8"	14"	20"	60110	60450	—
7/8"	20"	24"	60120	60460	—
7/8"	26"	30"	60130	60470	—
1"	6"	9"	60140	60480	—
1"	9"	14"	60150	60490	—
1"	14"	20"	60160	60500	—
1"	20"	24"	60170	60510	—
1"	26"	30"	60180	60520	—
1-1/8"	9"	14"	60190	60530	60880
1-1/8"	14"	20"	60200	60540	60890
1-1/8"	20"	24"	60210	60550	60900
1-1/8"	26"	30"	60220	60560	60910
1-1/4"	9"	14"	60230	60570	60920
1-1/4"	14"	20"	60240	60580	60930
1-1/4"	20"	24"	60250	60590	60940
1-1/4"	26"	30"	60260	60600	60950
1-3/8"	9"	14"	60270	60610	60960
1-3/8"	14"	20"	60280	60620	60970
1-3/8"	20"	24"	60290	60630	60980
1-3/8"	26"	30"	60300	60640	60990
1-1/2"	9"	14"	60310	60650	61000
1-1/2"	14"	20"	60320	60660	61010
1-1/2"	20"	24"	60330	60670	61020
1-1/2"	26"	30"	60340	60680	61030

Designed especially for dowel hole drilling.

ROCK DRILLS USING 7/8" x 3-1/4"

Manufacturer	Model Number
American Pneumatic Tool	115, 137, 155
Chicago Pneumatic Tool	CP-0014RR, CP-0022, CP-0032A-87
Harper Air Tool	4108, 4112
Ingersoll-Rand	JH30A1, JH40C1
Jet Equipment	RD-15, RD-30, RD-60
Sullair	MRD-30, MRD-40, MRD-50
Thor Power Tools	14D, 15D

ROCK DRILLS USING 7/8" x 4-1/4"

Manufacturer	Model Number
American Pneumatic Tool	137, 155
Chicago Pneumatic Tool	CP-0032A-87A
Harper Air Tool	4108, 4112
Ingersoll-Rand	JH30A2, JH40C2
Sullair	MRD-30, MRD-40, MRD-50, MRD-55

ROCK DRILLS USING 1" x 4 1/4"

Manufacturer	Model Number
American Pneumatic Tool	137, 155
Chicago Pneumatic Tool	CP-0032A-1, CP-0069
Harper Air Tool	4110, 4114
Ingersoll-Rand	JH30A3, JH40C3
Jet Equipment	RD-60
Sullair	MRD-40, MRD-50, MRD-55
Thor Power Tools	40066B, 40067B

NOTE:

Some rock drill models offer multiple chuck sizes. Please verify before ordering bits.



Drill Steel

Drill Rods

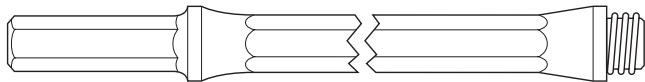

Length	"H" Thread 7/8" x 3-1/4" Shank	"E" Thread 7/8" x 3-1/4" Shank	"H" Thread 7/8" x 4-1/4" Shank	"H" Thread 1" x 4-1/4" Shank
	Part No.	Part No.	Part No.	Part No.
12"	64010	64015	64210	64410
18"	64020	64025	64220	64420
24"	64030	64035	64230	64430
30"	64040	64045	64240	64440
36"	64050	64055	64250	64450
48"	64060	64065	64260	64460
60"	64070	64075	64270	64470
72"	64080	64085	64280	64480
96"	64090	-	64290	64490
120"	64100	-	64300	64500

11° Tapered



Length	7/8" x 3-1/4" Shank	7/8" x 4-1/4" Shank	1" x 4-1/4" Shank
	Part No.	Part No.	Part No.
12"	64110	64310	64510
18"	64120	64320	64520
24"	64130	64330	64530
30"	64140	64340	64540
36"	64150	64350	64550
48"	64160	64360	64560
60"	64170	64370	64570
72"	64180	64380	64580
96"	64190	64390	64590
120"	64200	64400	64600

***NOTE:**
12° taper available upon request.
Longer lengths available upon request.



Carbide Rock Bits "H" Thread

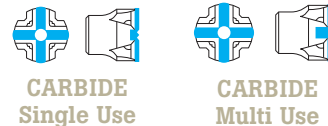

Diam.	Size Width	Part No.	Carbide Ht.	Part No.	Carbide Ht.
1 3/8"	8 mm	63010	7 mm	63220	11 mm
1 1/2"	8 mm	63020	7 mm	63230	11 mm
1 5/8"	9.5 mm	63030	7 mm	63240	14 mm
1 3/4"	9.5 mm	63040	7 mm	63250	14 mm
1 7/8"	9.5 mm	63050	7 mm	63260	14 mm
2"	9.5 mm	63060	7 mm	63270	14 mm
2 1/4"	9.5 mm	63070	7 mm	63280	14 mm
2 1/2"	9.5 mm	-	-	63290	14 mm
2 3/4"	9.5 mm	-	-	63300	14 mm
3"	9.5 mm	-	-	63310	14 mm

Carbide Rock Bits 11° Tapered

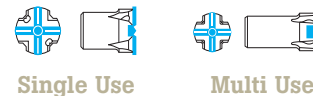

Steel	Diam.	Size Width	Part No.	Carbide Ht.	Part No.	Carbide Ht.
7/8"	1 1/8"	8 mm	63080	7 mm	-	-
7/8"	1 1/4"	8 mm	63090	7 mm	63320	11 mm
7/8"	1 3/8"	8 mm	63100	7 mm	63330	11 mm
7/8"	1 1/2"	8 mm	63110	7 mm	63340	11 mm
7/8"	1 5/8"	9.5 mm	63120	7 mm	63350	14 mm
7/8"	1 3/4"	9.5 mm	63130	7 mm	63360	14 mm
7/8"	1 7/8"	8 mm	63140	7 mm	-	-
7/8"	2"	8 mm	63150	7 mm	-	-
1"	1 3/8"	8 mm	63160	7 mm	-	-
1"	1 1/2"	8 mm	63170	7 mm	63370	11 mm
1"	1 5/8"	9.5 mm	63180	7 mm	63380	14 mm
1"	1 3/4"	9.5 mm	63190	7 mm	63390	14 mm

***NOTE:** 12° taper available upon request.

All Steel Rock Bits

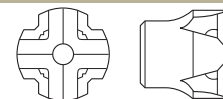

Part No.	Hole Dia.	Thread
63400	15/16"	"E"
63410	1"	"E"
63420	1 1/8"	"E"
64430	1 1/4"	"H"
63440	1 3/8"	"H"
63450	1 1/2"	"H"
63460	1 5/8"	"H"
63470	1 3/4"	"H"
63480	1 7/8"	"H"
63490	2"	"H"
63500	2 1/2"	"H"

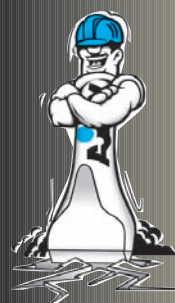
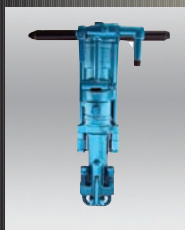

Electric Hammer Chisels



POINT STYLE

Moil Point



Flat Chisel



Scaling Chisel

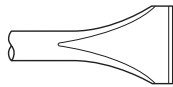

Slotting Tool



Seam Tool



Ground Rod Driver



Asphalt Cutter



Clay Spade



1pc. Bushing Tool



1pc. Bushing Tool with 25 Carbide Tips



2pc. Bushing Tool



Floor Scraper

Fits all SDS Max Style Rotary and Demolition Hammers used to remove ceramic and linoleum tile.

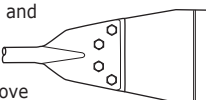

SDS MAX SHANK

For large rotary hammers with SDS-Max drive USA SDS-MAX LICENSED MANUFACTURER
Also fits Hilti TE-52/72/92

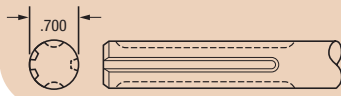

5/8" ROUND SPLINE SHANK

For large rotary hammers with spline drive

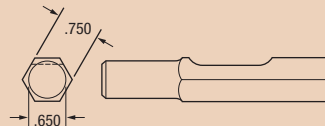

3/4" HEX DEMO SHANK

For demolition hammers which use 3/4" Hex Accessories

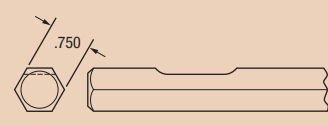

SDS MAX SHANK				5/8" ROUND SPLINE SHANK				3/4" HEX DEMO SHANK			
CAT.NO.	LENGTH	WIDTH	WT.	CAT.NO.	LENGTH	WIDTH	WT.	CAT.NO.	LENGTH	WIDTH	WT.
5801	12" 300 mm	1" 25 mm	1.25 lb .6 kg	5001	12" 300 mm	1" 25 mm	1.5 lb .7 kg	5201	12" 300 mm	1" 25 mm	1.5 lb .7 kg
5803	18" 450 mm	1" 25 mm	1.8 lb .8 kg	5003	18" 450 mm	1" 25 mm	2.25 lb 1 kg	5203	18" 450 mm	1" 25 mm	2.25 lb 1 kg
5803-24	24" 600 mm	1" 25 mm	2.5 lb 1.1 kg								
5807-36	36" 915 mm	—	3.75 lb 1.8 kg								
5805	12" 300 mm	—	1.25 lb .6 kg	5005	12" 300 mm	—	1.5 lb .7 kg	5205	12" 300 mm	—	1.5 lb .7 kg
5807	18" 450 mm	—	1.8 lb .8 kg	5007	18" 450 mm	—	2.25 lb 1 kg	5207	18" 450 mm	—	2.25 lb 1 kg
5807-24	24" 600 mm	1" 25mm	2.5 lb 1.1 kg								
5803-36	36" 915 mm	1" 25 mm	3.75 lb 1.8 kg								
5808	12" 300 mm	1 1/2" 38 mm	1.25 lb .6 kg	5008	12" 300 mm	1 1/2" 38 mm	1.7 lb .7 kg	5208	12" 300 mm	1 1/2" 38 mm	1.7 lb .7 kg
				5010	18" 450 mm	1 1/2" 38 mm	2.5 lb 1.1 kg	5210	18" 450 mm	1 1/2" 38 mm	2.5 lb 1.1 kg
5809	12" 300 mm	2" 50 mm	1.25 lb .6 kg	5009	12" 300 mm	2" 80 mm	1.75 lb .8 kg	5209	12" 300 mm	2" 80 mm	1.75 lb .8 kg
5811	18" 450 mm	2" 50mm	2.25 lb 1 kg	5011	18" 450 mm	2" 50 mm	2.5 lb 1.1 kg	5211	18" 450 mm	2" 50 mm	2.5 lb 1.1 kg
5812	12" 300 mm	3" 80 mm	1.5 lb .7 kg	5012	12" 300 mm	3" 80 mm	2.25 lb 1 kg	5212	12" 300 mm	3" 80 mm	2.25 lb 1 kg
5813	12" 300 mm	1 1/8" 28 mm	1.25 lb .6 kg	5013	12" 300 mm	1 1/8" 28 mm	1.5 lb .7 kg	5213	12" 300 mm	1 1/8" 28 mm	1.5 lb .7 kg
5815	15" 380 mm	1 1/8" 28 mm	1.5 lb .7 kg	5015	15" 380 mm	1 1/8" 28 mm	1.75 lb .8 kg	5215	15" 380 mm	1 1/8" 28 mm	1.75 lb .7 kg
5817	10 1/2" 260 mm	— —	2 lb .9 kg	5017	10 1/2" 260 mm	2" 50 mm	2.5 lb 1.1 kg	5217	10 1/2" 260 mm	2" 50 mm	2.5 lb 1.1 kg
5820	15 1/2" 400 mm	3 1/2" 90 mm	2.75 lb 1.2 kg					5220	15 1/2" 400 mm	5" 125 mm	4.75 lb 2.2 kg
5816	15 1/2" 400 mm	4 1/2" 110 mm	2.75 lb 1.2 kg	5016	15 1/2" 400 mm	4 1/2" 110 mm	4.75 lb 1.2 kg	5216	15 1/2" 400 mm	4 1/2" 110 mm	4.75 lb 1.2 kg
5818	9 1/2" 240 mm	— —	2.5 lb 1.1 kg	5018	9 1/2" 240 mm	— —	2.7 lb 1.2 kg	5218	9 1/2" 240 mm	— —	2.7 lb 1.2 kg
5818CB	9 1/2" 240 mm	— —	2 lb .9 kg	5018CB	9 1/2" 240 mm	— —	2.25 lb 1.1 kg	5218CB	9 1/2" 240 mm	— —	2.25 lb 1.1 kg
5819	10" 250 mm	— —	2.8 lb 1.2 kg	5019	10" 250 mm	— —	2.5 lb 1.1 kg	5219	10" 250 mm	— —	2.5 lb 1.1 kg
5821 stem only	8"	—	1.2 lb	5021 stem only		—	1 lb	5221 stem only		—	1 lb
5101 head only		—	1.6 lb	5101 head only		—	1.5 lb	5101 head only		—	1.5 lb
5822	25" 635 mm	6" 152 mm	5.5 lb								
5822-1	SDS Max Shank (Stem)										
5822-2	6" Flex Blade										
5822-3	Bolt (4 piece required)										
5822-4	Nut (4 piece required)										
5822-5	Bushing (2 piece required)										
5822-6	Plate (Blade Support)										



Electric Hammer Chisels

SDS PLUS SHANK

For small rotary hammers with SDS drive

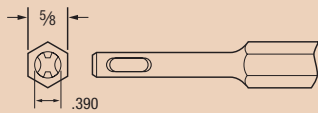

7/8" HEX HILTI SHANK

Fits Hilti TP-800

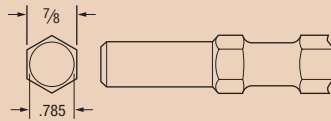

1 1/8" HEX SHANK

For electric breakers requiring 1 1/8" notched shanks

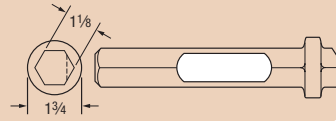

CAT.NO.	LENGTH	WIDTH	WT.	CAT.NO.	LENGTH	WIDTH	WT.	CAT.NO.	LENGTH	WIDTH	WT.
5705	10" 250 mm	—	.7 lb .29 kg	5605	12" 300 mm	—	2.0 lb .9 kg	31200E	14" 360 mm	—	6.5 lb 2.9 kg
				5607	18" 450 mm	—	3 lb 1.3 kg				
5701	10" 250 mm	1" 25 mm	.7 lb .29 kg	5601	12" 300 mm	—	1.7 lb .7 kg	31100E	14" 360 mm	1" 25 mm	6.5 lb 2.9 kg
5708	10" 250 mm	1 1/2" 40 mm	.8 lb .35 kg	5609	12" 300 mm	2" 80 mm	2.5 lb 1.1 kg	31300E	14" 360 mm	3" 25 mm	6.5 lb 2.9 kg
5715	10" 250 mm	7/8"	.8 lb								
								38400E	11" 275 mm	5" 125 mm	6.5 lb 2.9 kg
								39500E	16" 410 mm	5 1/2" 130 mm	9.75 lb 4.4 kg
5725	7"	.393"	.25 lb								
5726	7"	.551"	.25 lb								
5727	7"	.787"	.35 lb								
5728	7"	1.023"	.45 lb								
5729	7"	1.181"	.55 lb								

POINT STYLE

Moil Point

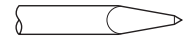

Flat Chisel



Scaling Chisel



Seam Tool



Asphalt Cutter



Clay Spade



Wood Chisel

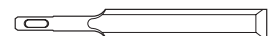

WARNING:
Wear Safety Goggles

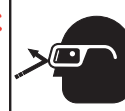

Riggers Tools: Pins / Barrel, Drift, Pull

POINT STYLE

Roof Pin



Single End Drift Pin

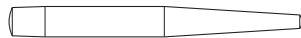

Barrel Drift Pin



Long Taper Drift Pin



Pull Pin



Welding Pin



Button Head Pin



Broad Head Bull Pin



CAT. NO.	STD. DIA.	OVERALL LENGTH	LENGTH OF TAPER	POINT SIZE	WEIGHT
600-R	13/32" (21MM)	4" (102MM)	2 1/2" (64MM)	1/8" (3MM)	1/8 LB.
601	7/16" (11MM)	6" (152MM)	2 1/2" (64MM)	3/16" (5MM)	1/4 LB.
602	9/16" (14MM)	6" (152MM)	2 3/4" (70MM)	1/4" (6MM)	1/3 LB.
603	11/16" (17MM)	6" (152MM)	2 3/4" (70MM)	5/16" (8MM)	1/2 LB.
624	13/16" (21MM)	8" (203MM)	3 3/4" (95MM)	5/16" (8MM)	1 LB.
625	15/16" (24 MM)	8" (203MM)	3 3/4" (95MM)	3/8" (13MM)	11/4 LB.
626	1 1/16" (27MM)	8" (203MM)	3 3/4" (95MM)	1/2" (14MM)	15/8 LB.
611	7/16" (11MM)	6" (152MM)	2" (51MM)	3/16" (5MM)	1/4 LB.
612	9/16" (14MM)	6" (152MM)	2" (51MM)	1/4" (6MM)	1/3 LB.
613	11/16" (17MM)	6" (152MM)	2" (51MM)	5/16" (8MM)	1/2 LB.
633	11/16" (17MM)	7 1/2" (201MM)	2" (51MM)	5/16" (8MM)	5/8 LB.
614	13/16" (21MM)	6" (152MM)	2" (51MM)	7/16" (11MM)	3/4 LB.
634	13/16" (21MM)	8" (203MM)	2 1/2" (64MM)	3/8" (13MM)	7/8 LB.
615	15/16" (24 MM)	6" (152MM)	2" (51MM)	1/2" (14MM)	7/8 LB.
635	15/16" (24 MM)	8" (203MM)	2 1/2" (64MM)	7/16" (11MM)	11/8 LB.
636	1 1/16" (27MM)	8" (203MM)	2 1/2" (64MM)	9/16" (14MM)	11/2 LB.
637	1 3/16" (30MM)	8" (203MM)	2 1/2" (64MM)	3/4" (19MM)	2 LB.
638	1 5/16" (33MM)	8" (203MM)	2 1/2" (64MM)	3/4" (19MM)	21/3 LB.
642	9/16" (14MM)	7" (178MM)	6" (152MM)	1/8" (3MM)	1/3 LB.
643	11/16" (17MM)	7 1/2" (201MM)	6 1/2" (165MM)	3/16" (5MM)	1/2 LB.
644	13/16" (21MM)	8" (203MM)	7" (178MM)	3/16" (5MM)	5/8 LB.
645	15/16" (24 MM)	8" (203MM)	7" (178MM)	1/4" (6MM)	7/8 LB.
646	1 1/16" (27MM)	8" (203MM)	7" (178MM)	5/16" (8MM)	11/8 LB.
651-12	15/16" (24 MM)	12" (305MM)	10" (254MM)	5/16" (8MM)	11/2 LB.
652-12	1 1/16" (27MM)	12" (305MM)	10" (254MM)	3/8" (13MM)	15/8 LB.
653-12	1 3/16" (30MM)	12" (305MM)	10 1/2" (267MM)	7/16" (11MM)	2 LB.
654-12	1 1/4" (32MM)	12" (305MM)	10 1/2" (267MM)	7/16" (11MM)	21/3 LB.
651	15/16" (24 MM)	15" (381MM)	10" (254MM)	5/16" (8MM)	2 LB.
652	1 1/16" (27MM)	15" (381MM)	10" (254MM)	3/8" (13MM)	21/2 LB.
653	1 3/16" (30MM)	15" (381MM)	10 1/2" (267MM)	7/16" (11MM)	3 LB.
654	1 1/4" (32MM)	15" (381MM)	10 1/2" (267MM)	7/16" (11MM)	31/4 LB.
656	15/16" (24 MM)	12" (305MM)	11" (279MM)	3/16" (5MM)	11/8 LB.
657	1 1/16" (27MM)	12" (305MM)	11" (279MM)	1/4" (6MM)	11/2 LB.
658	1 3/16" (30MM)	12" (305MM)	11" (279MM)	1/4" (6MM)	17/8 LB.
648	1 1/16" (27MM)	13" (330MM)	10 5/8" (267MM)	1/4" (6MM)	21/4 LB.
649	1 1/16" (27MM)	10" (254MM)	8" (203MM)	1/4" (6MM)	15/8 LB.
650	1 1/4" (32MM)	13" (330MM)	10" (254MM)	5/16" (8MM)	3 LB.

WARNING:
Wear Safety
Goggles



NOTE: Other sizes available upon request. Pins are 1/16" larger than the Bolt or Hole. Example: 13/16" diameter pin used for 3/4" bolt or hole.

Chisel Bars



Extra long heavy duty chisels. One end forged to chisel point — other end with chisel head for striking.

Cat. No.	Stock Size	Length	Weight
695	5/8" (16mm) Hex	18" OAL (457mm)	1.5 lb.
696	3/4" (19mm) Hex	24" OAL (610mm)	3 lb.
697	7/8" (22mm) Hex	30" OAL (762mm)	5.25 lb.
698	1" (25mm) Hex	36" OAL (914mm)	8.5 lb.

Fit Up Bar – Goose Neck



One end tapered — other end with chisel point and goose neck offset.

Cat. No.	Stock Size	Length	Weight
660	7/8" (22mm) Hex	30" OAL (762mm)	5 lb.
686	7/8" (22mm) Hex	48" OAL (1219mm)	8.5 lb.
687	1" (25mm) Hex	48" OAL (1219mm)	10.75 lb.

Pinch Bars



Cat. No.	Stock Size	Length	Weight
680	3/4" (19mm) Hex	24" OAL (610mm)	3 lb.
681	3/4" (19mm) Hex	30" OAL (762mm)	3.75 lb.
682	7/8" (22mm) Hex	36" OAL (914mm)	6 lb.

Pry Bars with Handles

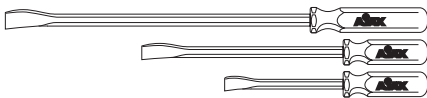

Cat. No.	Stock Size	Overall Length	Blade Width
675-7	3/8" (10mm)	12" (305mm)	5/8" (16mm)
675-12	3/8" (10mm)	17" (432mm)	5/8" (16mm)
675-18	1/2" (13mm)	25" (635mm)	11/16" (17mm)
675-24	1/2" (13mm)	31" (787mm)	11/16" (17mm)
675-28	5/8" (16mm)	36" (914mm)	7/8" (22mm)
675-SP	3 pc. Set, includes 675-7, 675-12, 675-18		

Lining Bars – Offset Pinch or Jimmy Bar



One end tapered for lining holes, etc. — other end with chisel end and slight offset. For extra leverage in positioning steel members.

Cat. No.	Stock Size	Length	Weight
666	5/8" (16mm) Hex	15" OAL (381mm)	1.25 lb.
667	3/4" (19mm) Hex	20" OAL (508mm)	2.5 lb.
683	7/8" (22mm) Hex	30" OAL (762mm)	4.75 lb.
684	1" (25mm) Hex	36" OAL (914mm)	8 lb.

Pry Bars

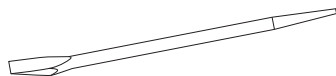

New dimensions in pry bars forged from the finest alloy steel and tempered to give added muscle to that tough application.

Cat. No.	Stock Size	Length	Weight
9118	2 1/32" (17mm) RD	18" OAL (457mm)	1.5 lb.
9124	3/4" (19mm) RD	24" OAL (610mm)	2.5 lb.
9130	7/8" (22mm) RD	30" OAL (762mm)	4.5 lb.
9146	7/8" (22mm) RD	46" OAL (1168mm)	7.25 lb.
9154	1 1/16" (27mm) RD	54" OAL (1372mm)	12.75 lb.

Digging Bars

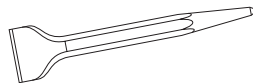

Cat. No.	Stock Size	Length	Weight
676	1" (25mm) Hex	60" OAL (1524mm)	14.5 lb.
677	1" (25mm) Hex	72" OAL (1829mm)	17.5 lb.

Crowbar Pinch Point



Cat. No.	Point Size & Length	Weight
9160P	1 1/4" sq. X 60" Pinch Point/Lining Bar	18 lb.

Crowbar Wedge Point



Cat. No.	Point Size & Length	Weight
9160W	1 1/4" sq. X 60" Wedge Point/Lining Bar	18 lb.

Connecting – Straight Fit Up Bar

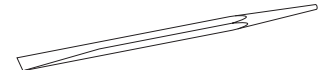

Same as lining bar: one end tapered, chisel point on other end. No offset.

Cat. No.	Stock Size	Length	Weight
685	3/4" (19mm) Hex	24" OAL (610mm)	2.75 lb.
693	3/4" (19mm) Hex	30 1/2" OAL (775mm)	4 lb.
668	7/8" (22mm) Hex	30" OAL (762mm)	4.75 lb.
669	7/8" (22mm) Hex	36" OAL (914mm)	5.75 lb.
670	1" (25mm) Hex	36" OAL (914mm)	8 lb.

Pry Bars (Nickel Chrome Plated)



Forged from the finest alloy steel and tempered for added strength.

Cat. No.	Stock Size	Length	Weight
9118-PL	2 1/32" (17mm) RD	18" OAL (457mm)	1.5 lb.
9124-PL	3/4" (19mm) RD	24" OAL (610mm)	2.5 lb.
9130-PL	7/8" (22mm) RD	30" OAL (762mm)	4.5 lb.

Pry Bars Scraper

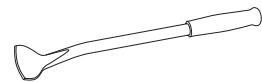

Excellent leverage from offset blade. Ideal for lifting old tile, removing moldings, scraping paint and hardened adhesives. Comes with plastic grip.

Cat. No.	Stock Size	Length	Weight
692	2 3/16" (56mm)	16 3/4" OAL (425mm)	1.5 lb.

Utility Bar-Goose Neck/Pinch Point (Nickel Chrome Plated)

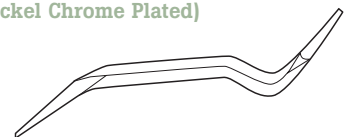

Two different chisel points for dual leverage.

Cat. No.	Stock Size	Length	Weight
678-PL	7/8"	36" OAL	9 lb.
679-PL	1"	48" OAL	12 lb.

COTTER PIN PULLER & SPREADER

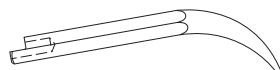

Cat. No.	Size Stock	Length	Weight
690	3/4"	12"	1.25 lb.

COTTER PIN PULLER

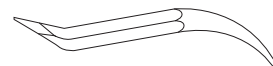

Cat. No.	Size Stock	Length	Weight
691	3/4"	11"	1.25 lb.

Solid Punch



Cat. No.	Stock Size	Overall Length	Point Diameter
570	5/16" (8mm)	6" (152mm)	3/32" (2mm)
571	3/8" (10mm)	6" (152mm)	1/8" (3mm)
572	1/2" (13mm)	6" (152mm)	3/16" (5mm)
573	5/8" (16mm)	7" (178mm)	1/4" (6mm)

Center Punch

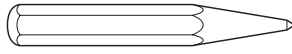

Cat. No.	Stock Size	Overall Length
561	3/8" (10mm)	6" (152mm)
562	1/2" (13mm)	6" (152mm)
563	5/8" (16mm)	6" (152mm)
564	3/4" (19mm)	6" (152mm)
565	7/8" (22mm)	6" (152mm)

Long Taper Punch

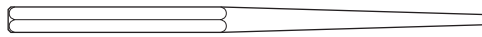

Cat. No.	Stock Size	Overall Length	Point Diameter
586	3/8" (10mm)	7 1/2" (190mm)	3/32" (2mm)
587	3/8" (10mm)	8" (203mm)	1/8" (3mm)
588	1/2" (13mm)	8 1/2" (216mm)	5/32" (4mm)
589	1/2" (13mm)	9" (229mm)	3/16" (5mm)
590	5/8" (16mm)	11" (280mm)	1/4" (6mm)
591	5/8" (16mm)	11" (280mm)	5/16" (8mm)

Hand Pin Punch

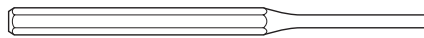

Cat. No.	Stock Size	Overall Length	Point Diameter
580	5/16" (8mm)	4 3/4" (121mm)	3/32" (2mm)
581	5/16" (8mm)	5" (127mm)	1/8" (3mm)
582	5/16" (8mm)	5 1/4" (133mm)	5/32" (4mm)
583	5/16" (8mm)	5 1/2" (140mm)	3/16" (5mm)
584	3/8" (10mm)	7" (178mm)	1/4" (6mm)
585	1/2" (13mm)	7" (178mm)	5/16" (8mm)

Prick Punch

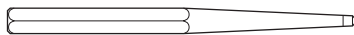

Cat. No.	Stock Size	Overall Length
592	3/8" (10mm)	5" (127mm)

Wood Chisel



Cat. No.	Stock Size	Overall Length
515	7/8" (22mm)	12" (305mm)

Hand Flat Chisel

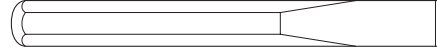

Cat. No.	Stock Size	Overall Length	Cutting Edge Width
501	5/16" (8mm)	5" (127mm)	3/8" (10mm)
502	3/8" (10mm)	6" (152mm)	1/2" (13mm)
503	1/2" (13mm)	6" (152mm)	5/8" (16mm)
504	5/8" (16mm)	7" (178mm)	3/4" (19mm)
505	3/4" (19mm)	6" (152mm)	7/8" (22mm)
506	3/4" (19mm)	8" (203mm)	7/8" (22mm)
507	3/4" (19mm)	10" (254mm)	7/8" (22mm)
508	3/4" (19mm)	12" (305mm)	7/8" (22mm)
509	7/8" (22mm)	6" (152mm)	1" (25mm)
510	7/8" (22mm)	9" (229mm)	1" (25mm)
511	7/8" (22mm)	12" (305mm)	1" (25mm)
512	1" (25mm)	9" (229mm)	1 1/8" (29mm)
513	1" (25mm)	12" (305mm)	1 1/8" (29mm)
516	3/4" (19mm)	8" (203mm)	1 1/2" (38mm)
517	3/4" (19mm)	10" (254mm)	1 1/2" (38mm)
518	7/8" (22mm)	9" (229mm)	2" (51mm)
519	1" (25mm)	12" (305mm)	2" (51mm)

Hand Round Nose Chisel

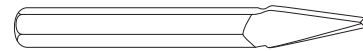

Cat. No.	Stock Size	Overall Length	Cutting Edge Width
531	5/16" (8mm)	5" (127mm)	1/8" (3mm)
532	3/8" (10mm)	6" (152mm)	5/32" (4mm)
533	1/2" (13mm)	6" (152mm)	3/16" (5mm)
534	5/8" (16mm)	7" (178mm)	1/4" (6mm)
535	3/4" (19mm)	8" (203mm)	3/8" (10mm)
536	7/8" (22mm)	9" (229mm)	1/2" (13mm)

Hand Cape Chisel

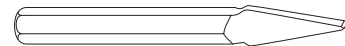

Cat. No.	Stock Size	Overall Length	Cutting Edge Width
521	5/16" (8mm)	5" (127mm)	1/8" (3mm)
522	3/8" (10mm)	6" (152mm)	5/32" (4mm)
523	1/2" (13mm)	6" (152mm)	3/16" (5mm)
524	5/8" (16mm)	7" (178mm)	1/4" (6mm)
525	3/4" (19mm)	8" (203mm)	3/8" (10mm)
526	7/8" (22mm)	9" (229mm)	1/2" (13mm)

Hand Diamond Point Chisel



Cat. No.	Stock Size	Overall Length	Cutting Edge Width
541	5/16" (8mm)	5" (127mm)	1/8" (3mm)
542	3/8" (10mm)	6" (152mm)	5/32" (4mm)
543	1/2" (13mm)	6" (152mm)	3/16" (5mm)
544	5/8" (16mm)	7" (178mm)	1/4" (6mm)
545	3/4" (19mm)	8" (203mm)	3/8" (10mm)
546	7/8" (22mm)	9" (229mm)	1/2" (13mm)



WARNING:
Wear Safety
Goggles



WARNING:
Wear Safety
Goggles



Wedges / Scrapers

Cat. No.	Height	Width	Length	Weight
881	1/4" (6mm)	3/4" (19mm)	3" (76mm)	1 oz.
882	1/2" (13mm)	1" (25mm)	6" (152mm)	7 oz.
883	3/4" (19mm)	1 1/2" (38mm)	8" (203mm)	1 lb.
884	1" (25mm)	1 1/2" (38mm)	8" (203mm)	1 lb. 5 oz.
885	1 1/4" (32mm)	1 1/4" (32mm)	8" (203mm)	2 lb.
886	1 1/2" (38mm)	1 1/2" (38mm)	10" (254mm)	3 lb.
887	1 3/4" (44mm)	1 3/4" (44mm)	12" (305mm)	5 lb.
888	2" (51mm)	2" (51mm)	12" (305mm)	7 lb.

Stock Wedges

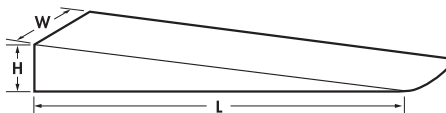

WEDGES FOR THE TOUGH JOBS

AJAX Wedges are made of Carbon Steel, properly forged for maximum toughness.

NOTE:

Wedges to your specification can be furnished, made of carbon or mild steel. Please state height (H), width (W), and length (L) required.

Cat. No.	Blade Height	Blade Width	Blade Lgth.	Weight
875	7/8" (22mm)	7/8" (22mm)	11" (279mm)	1.25
875-BC*	7/8" (22mm)	7/8" (22mm)	11" (279mm)	1.25

Flange Wedges



*Beryllium Copper Non-Spark Material (See page 20)

Slightly concave wedging surfaces for interlocking safety when used in PAIRS.

Cat. No.	Blade Height	Blade Width	Blade Length	Weight
876	13/16" (21mm)	13/16" (21mm)	12" (305mm)	1.5
876-BC*	13/16" (21mm)	13/16" (21mm)	12" (305mm)	1.5

Banana Wedges



*Beryllium Copper Non-Spark Material (See page 20)

Cat. No.	Length	For Bolt Holes:	Weight
879-P	4 1/2" (114mm)	5/8" (16mm), 3/4" (19mm), 7/8" (22mm), 1" (25mm), 1 1/8" (29mm)	1.75
880-P	7 1/2" (191mm)	1 1/4" (32mm), 1 3/8" (35mm), 1 1/2" (38mm), 1 5/8" (41mm), 1 3/4" (44mm)	1.75

Flange Line Up Pin (sold in pairs)

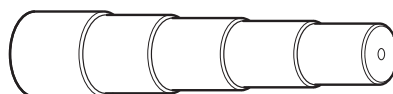

Cat. No.	Length	Blade Width	Weight
891-P	12" (305mm)	1 1/4" (32mm)	6.75

Flange Scraper



Packaged 25 pcs. per bundle

Cat. No.	Length	Blade Width	Weight
892	9" (229mm)	1 1/4" (32mm)	.5

Double End Scraper



WARNING:
Wear Safety
Goggles



Demolition Tools for Hydraulic Mounted Breakers



To inquire, please have the following information available:

- 1) Manufacture & Model Number of hydraulic breaker
- 2) Type of Point Style

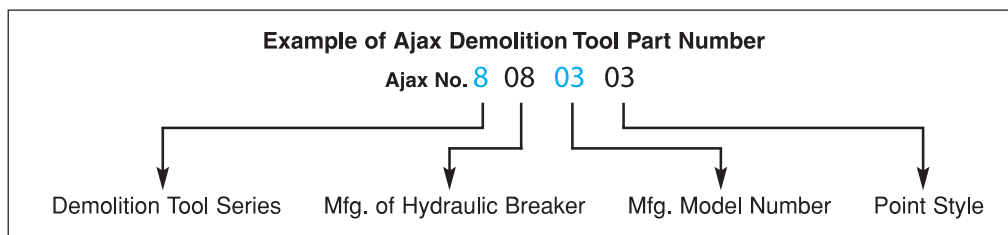

POINT STYLES

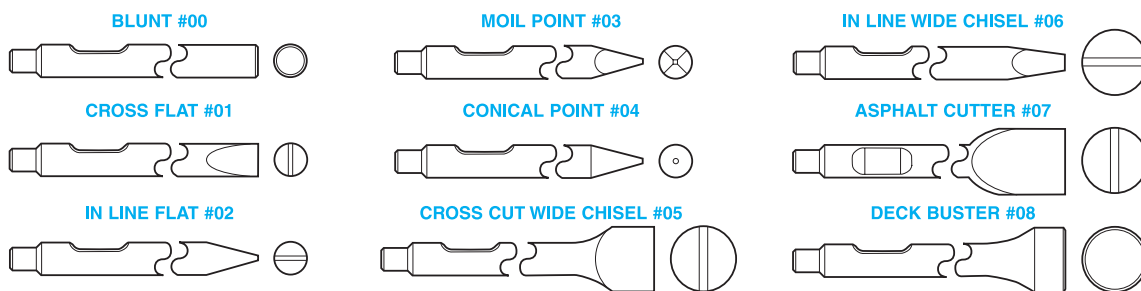

SPECIAL APPLICATION BITS

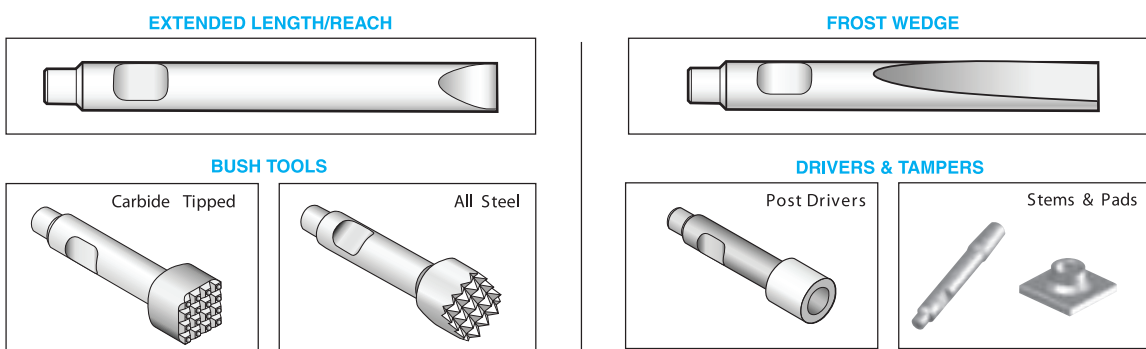

Call Today, Let AJAX Engineer the Right Tool for Special Applications
800.323.9129 or 847.455.5420



Design Your Own Custom Tool

PART NUMBER

Design and Sketch tool with dimensions, and fax to Ajax for quotation.

AJAX Tool Works
INCORPORATED

10801 FRANKLIN AVENUE • FRANKLIN PARK, ILLINOIS 60131
847 455 5420 • Toll Free: 800 323 9129
Fax: 847 455 9242 • Toll Free Fax: 800 424 2529

DRAWN BY DATE SCALE PART NO.

CUSTOMER

REVISIONS

NO.	DESCRIPTION



1-800-323-9129



1-800-424-AJAX



ajaxtools.com

RIVET BUSTER TOOLS
RIVET BUSTER CHISELS ARE USED IN THE CONSTRUCTION INDUSTRY TO CUT RIVET HEADS AND KNOCK OUT RIVET BODIES OR FOR DEMOLITION TASKS SUCH AS BREAKING CONCRETE OR MORTAR.

Search by Product Type:
Chipping Hammer Tools
Demolition Tools
Drill Steel Tools
Electric Hammer Tools
Hand Tools
Oilers & Lubricators
Paving Breaker Tools
Pins
Rivet Buster Tools
Safety Tools
Wedges & Scrapers
Weld Flux Scalars
Zip Gun Chisels

FIND AN AJAX REP
Use our Rep Locator to find an Ajax Representative in your area

DOWNLOAD THE CATALOG
Find what you're looking for in our full-line product catalog in pdf format

Ready to SHIP
MADE IN THE USA

Search by Application: [] **Go**

© 2006 Ajax Tools. Powered by IntelioQuence

Product Applications:
excavation, cutting steel beams, demolition, demolishing, breaking concrete, weather steel, refractory linings in furnaces, chipping steel

View Technical Drawings

Product Applications:
excavation, cutting steel beams, demolition, demolishing, breaking concrete, weather steel, refractory linings in furnaces, chipping steel

View Technical Drawings

Product Applications:
excavation, cutting steel beams, demolition, demolishing, breaking concrete, weather steel, refractory linings in furnaces, chipping steel

View Technical Drawings

The greatest tools online and on the job 24-7-365.

Ajax Tool Works Incorporated
10801 Franklin Ave. • Franklin Park, IL 60131
847/455-5420 • 800/323-9129
847/455-9242 • 800/424-2529 toll free fax
www.ajaxtools.com • info@ajaxtools.com

